

图

版

車 上 り 瓦 窯 跡

図版第一 車上り瓦窯跡周辺地形図

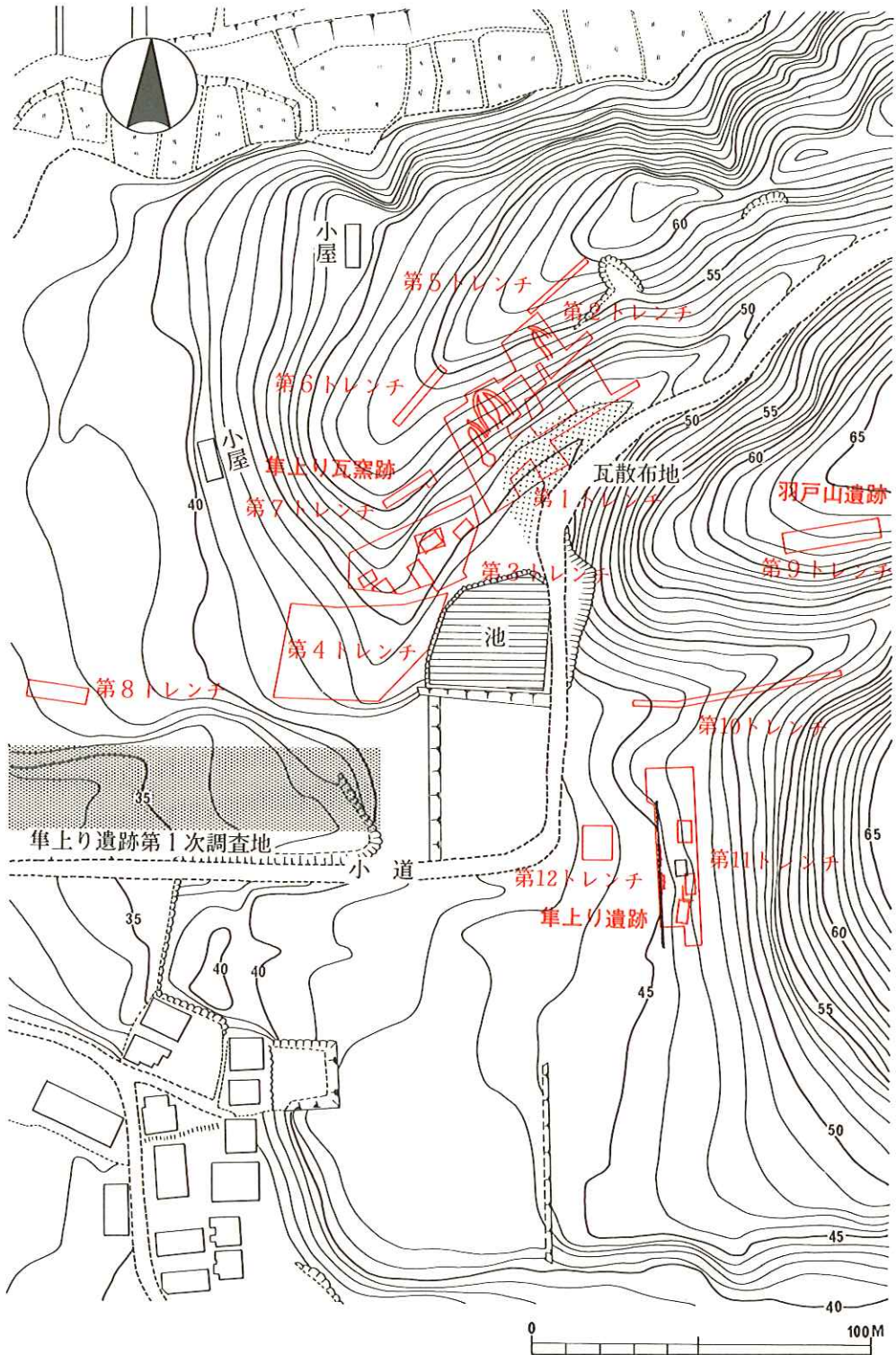

集上り瓦窯跡

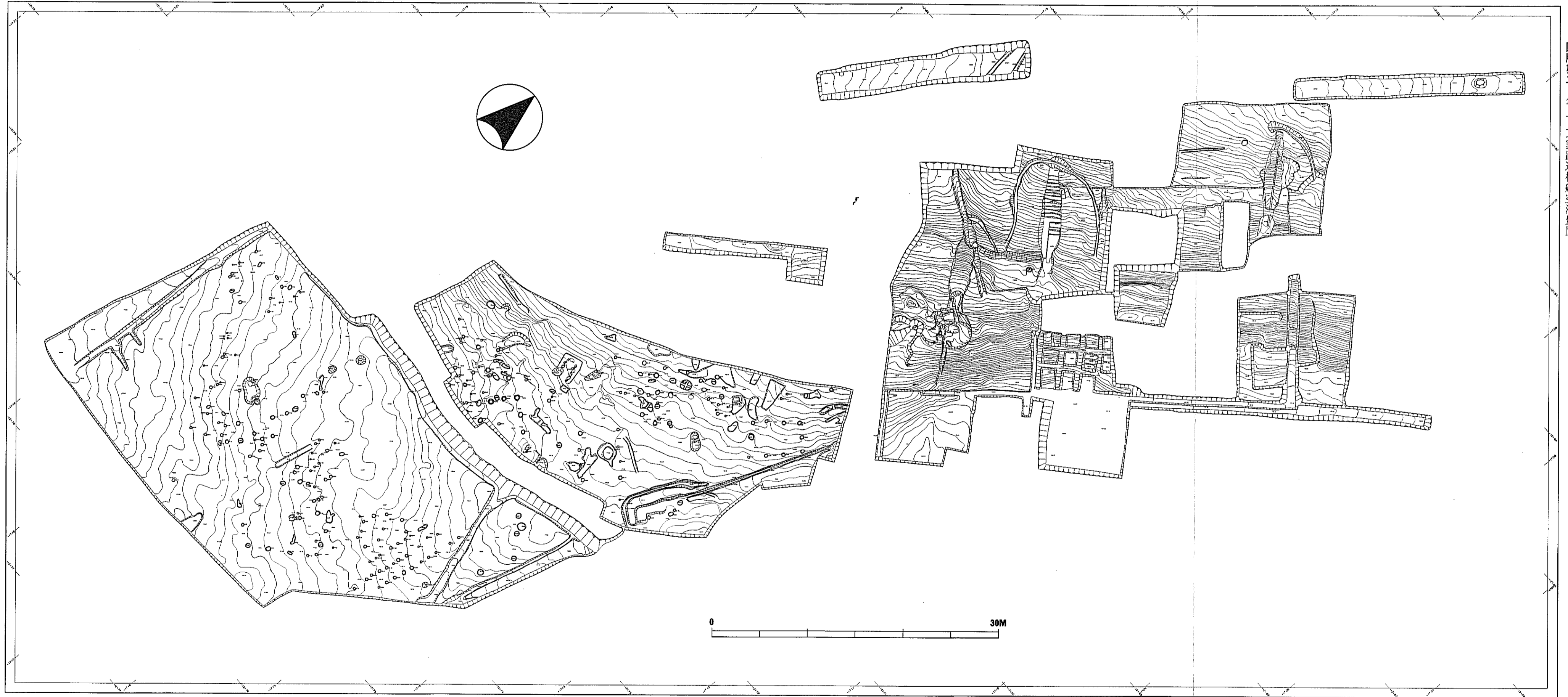

隼上り瓦窯跡

図版第三 遺構実測図1 (1号窯平面図)

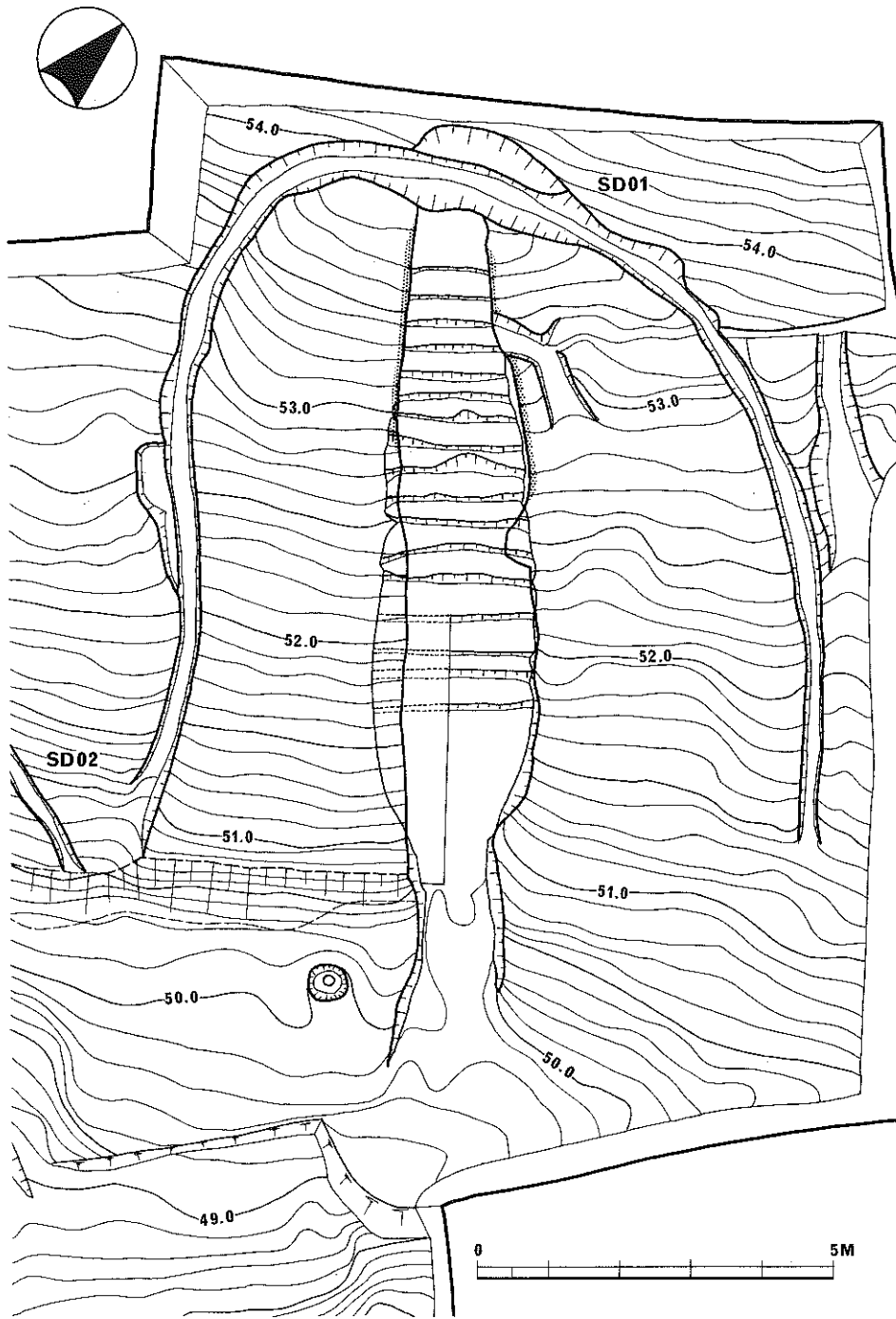

隼上り瓦窯跡

図版第四 遺構実測図2 (1号窯断面図)

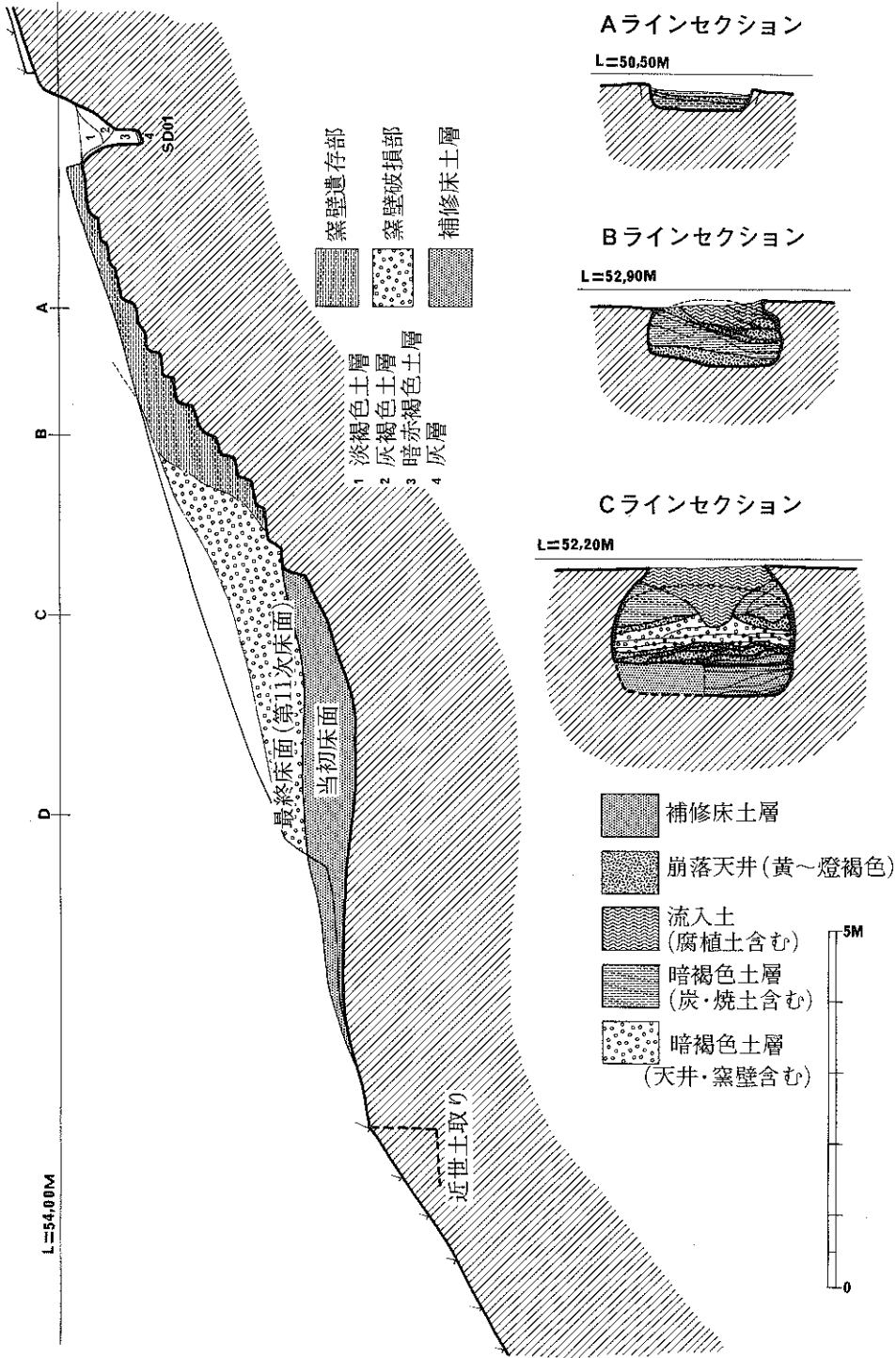

集上り瓦窯跡

図版第五 遺構実測図3 (2号窯平面図)

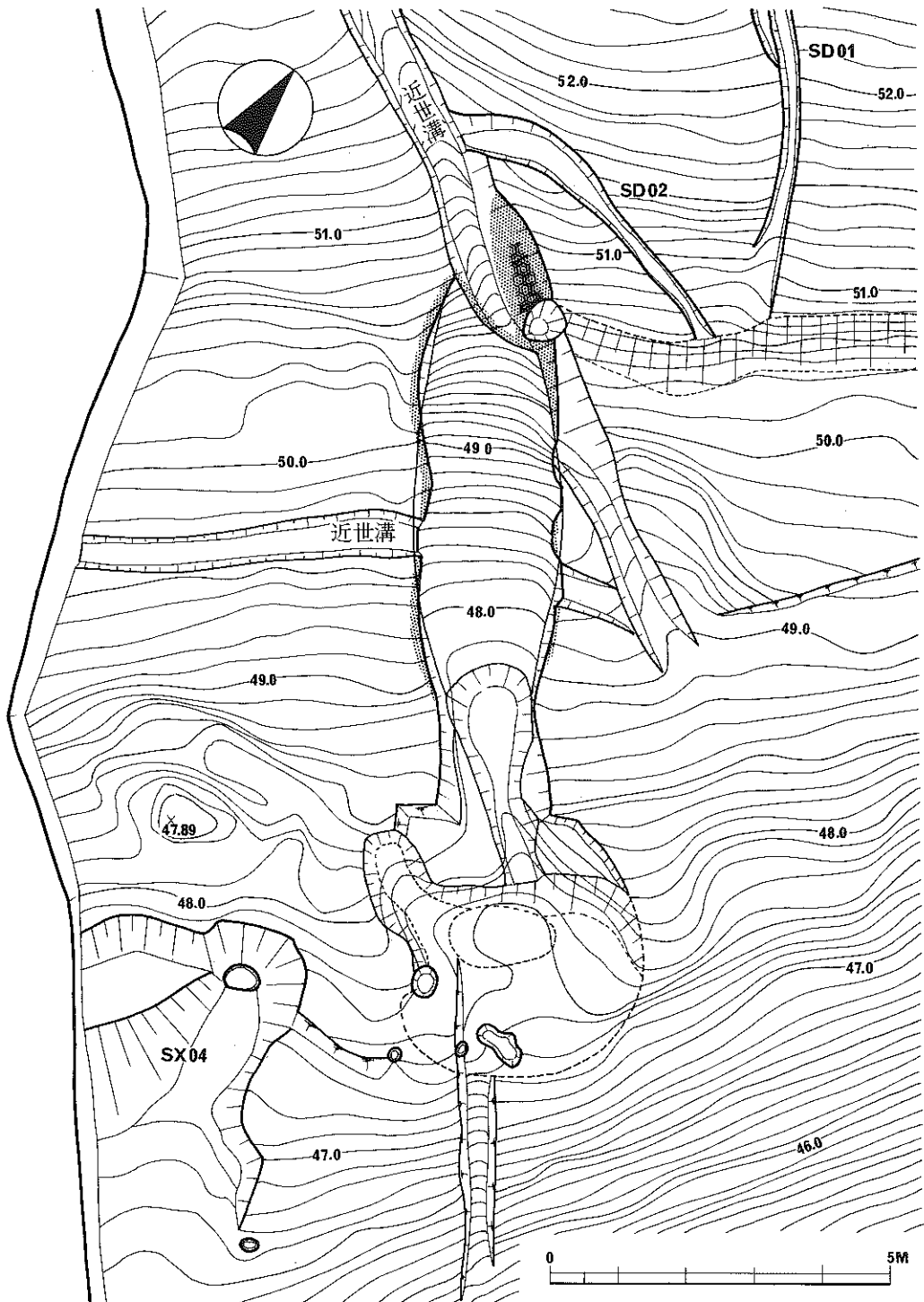

隼上り瓦窯跡

図版第六 遺構実測図4 (2号窯断面図)

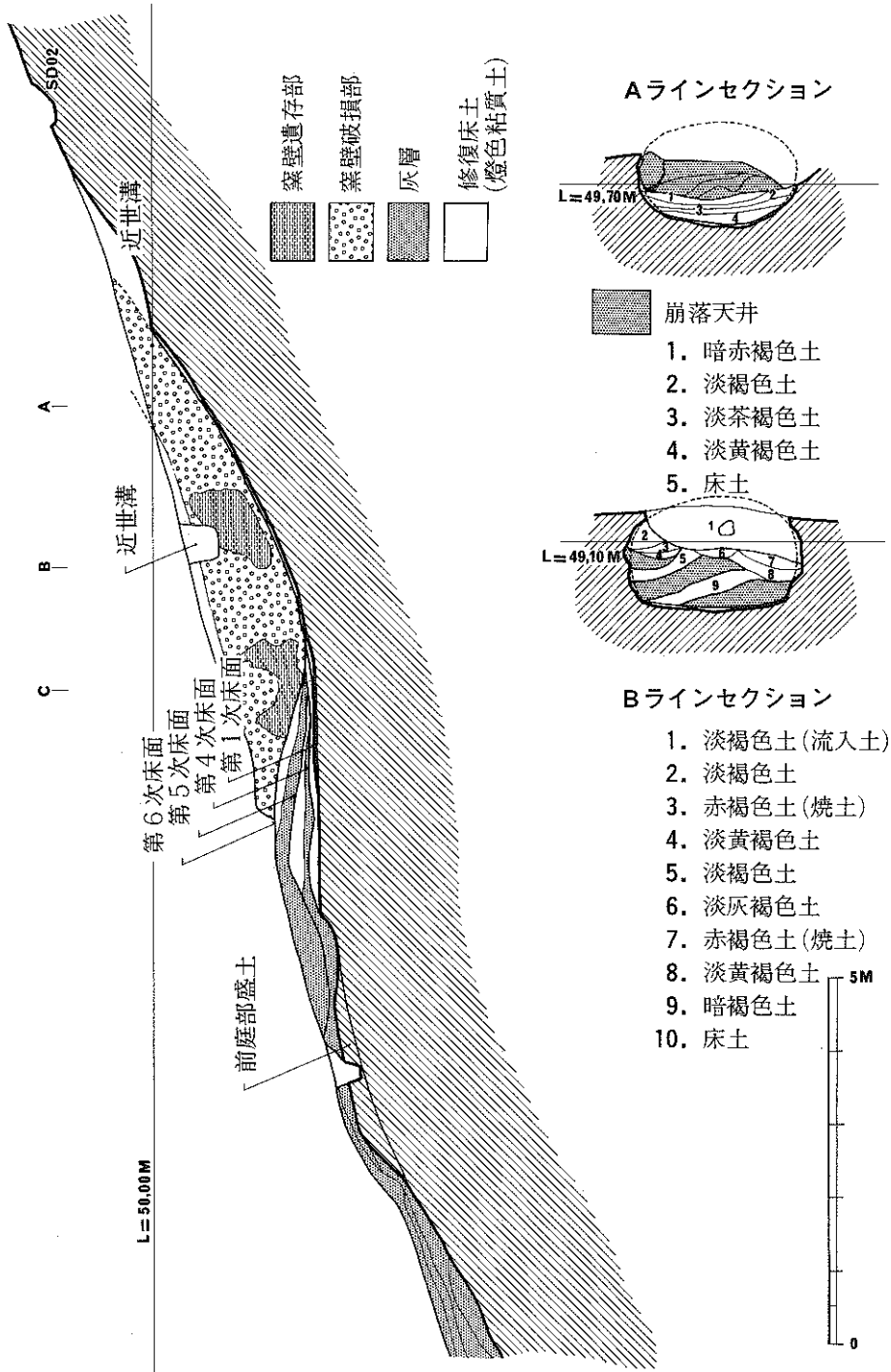

隼上り瓦窯跡

図版第七 遺構実測図5 (3号窯平面図)

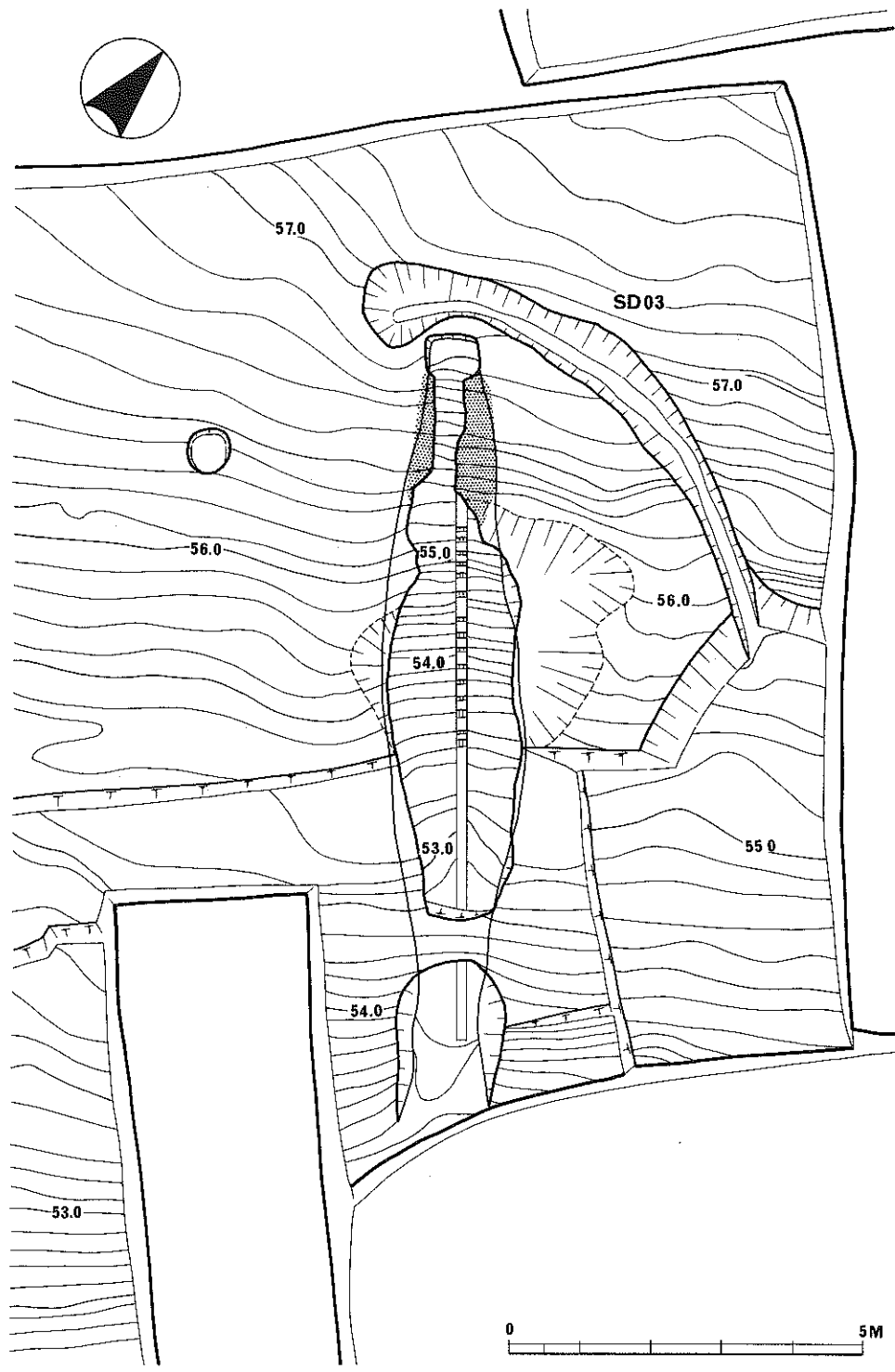

隼 上 り 瓦 窯 跡

図版第八 遺構実測図6 (3号窯断面図)

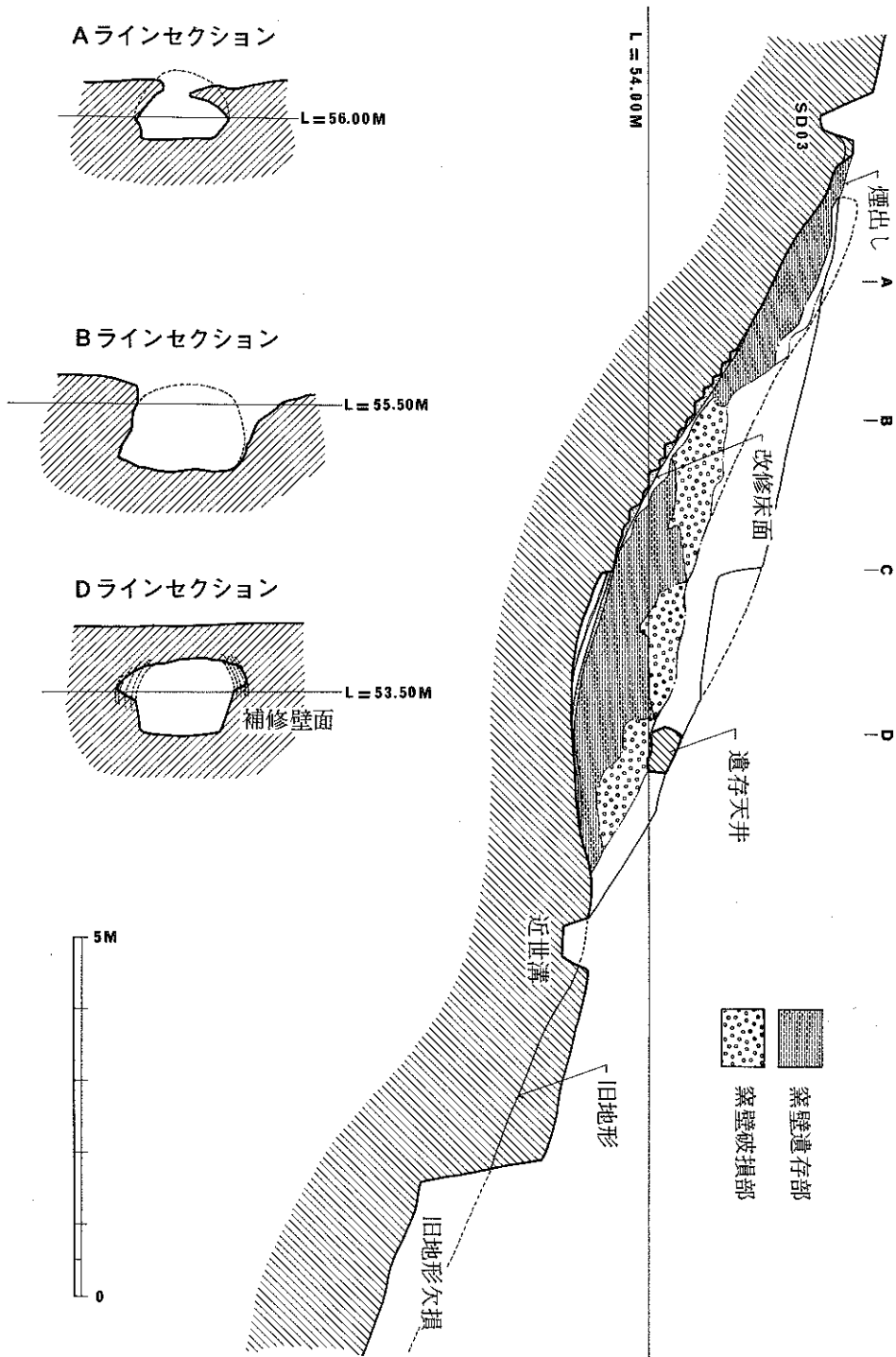

隼上り瓦窯跡

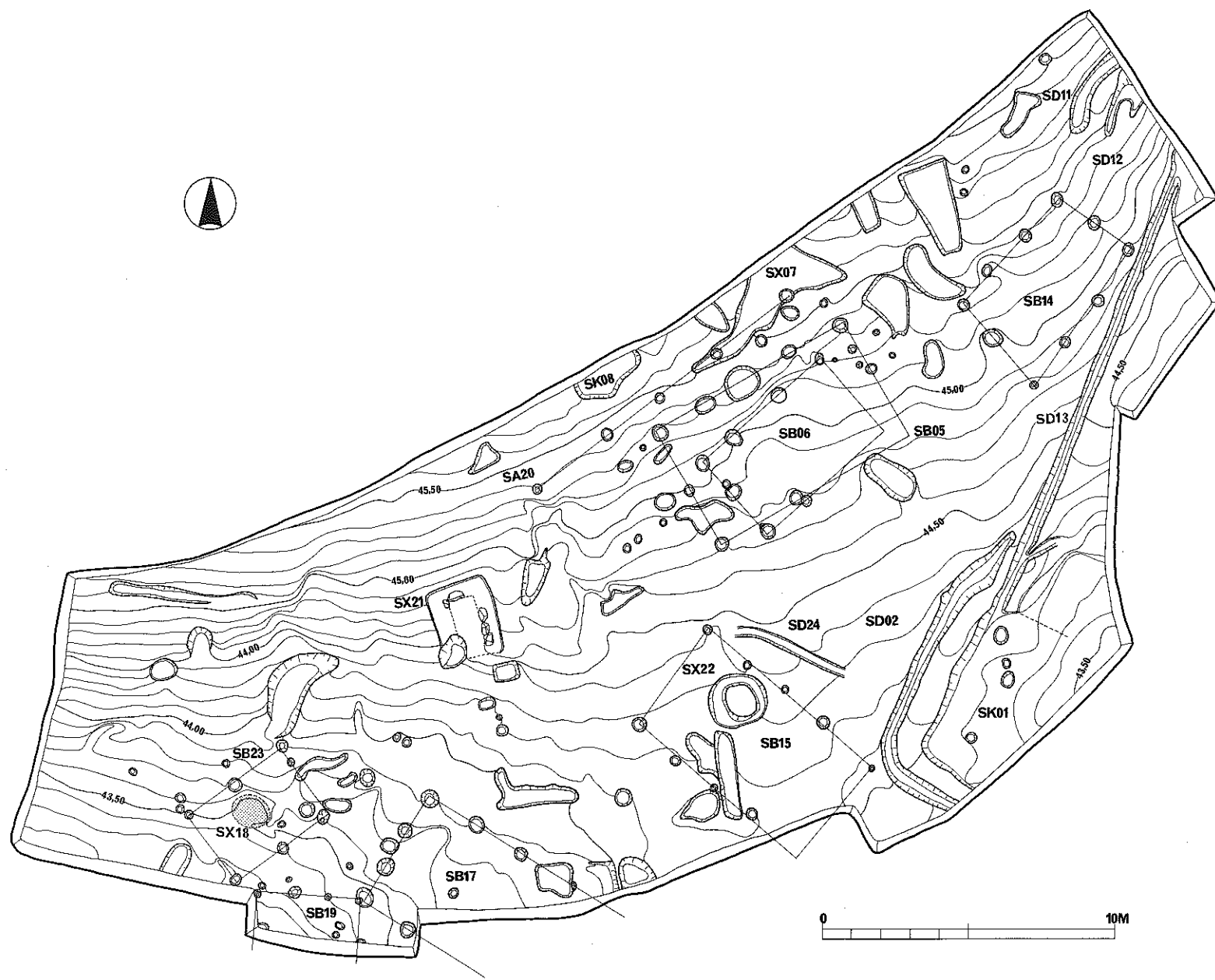

図版第九 遺構実測図7 (工房跡) (第3トレンチ平面図)

隼上り瓦窯跡

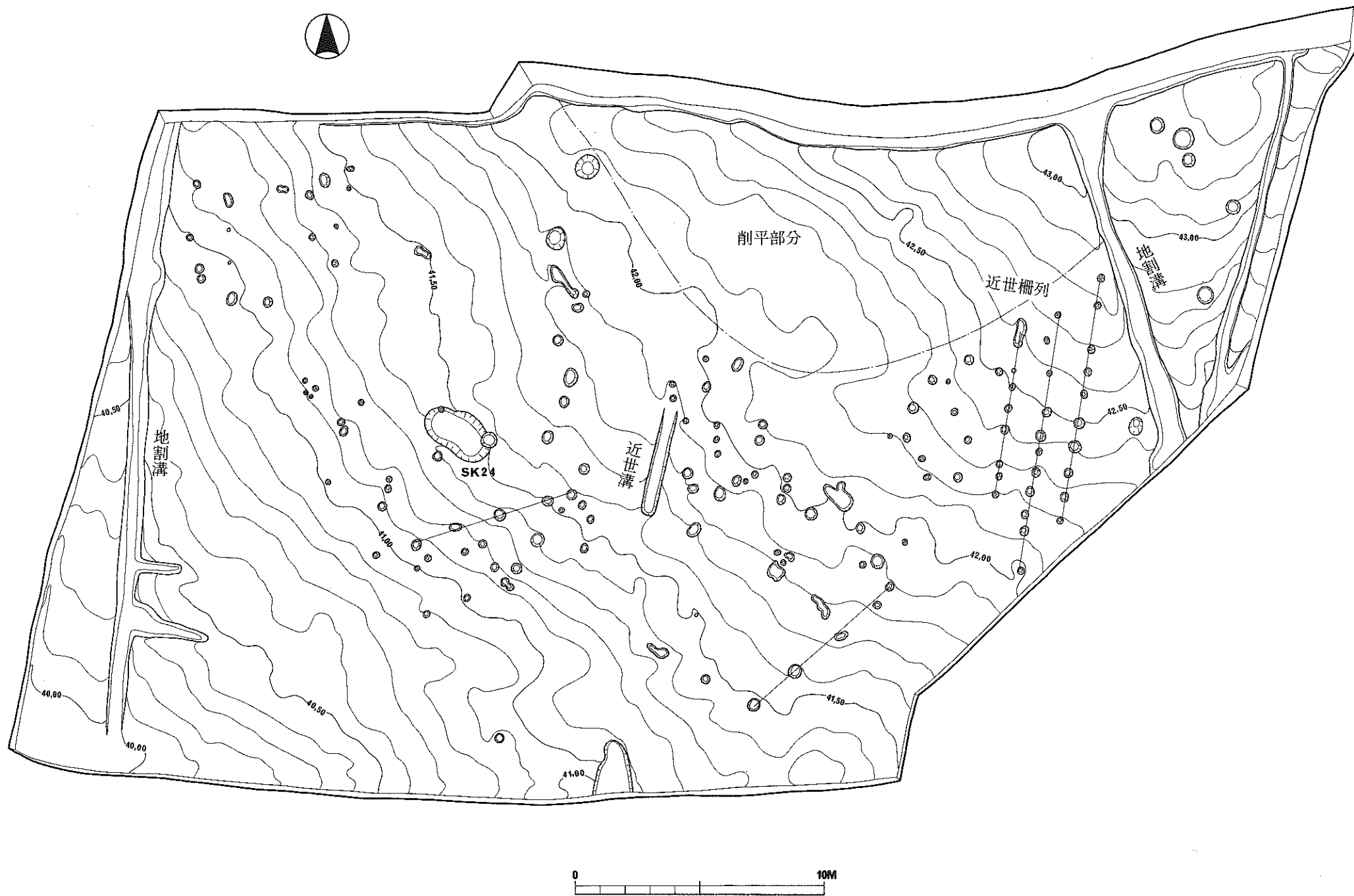

図版第一〇 遺構実測図8 「工房跡」(第4トレンチ平面図)

隼上り瓦窯跡

図版第一一 遺構実測図9〔工房跡〕(第3トレンチSK01・SD02・SD13実測図)

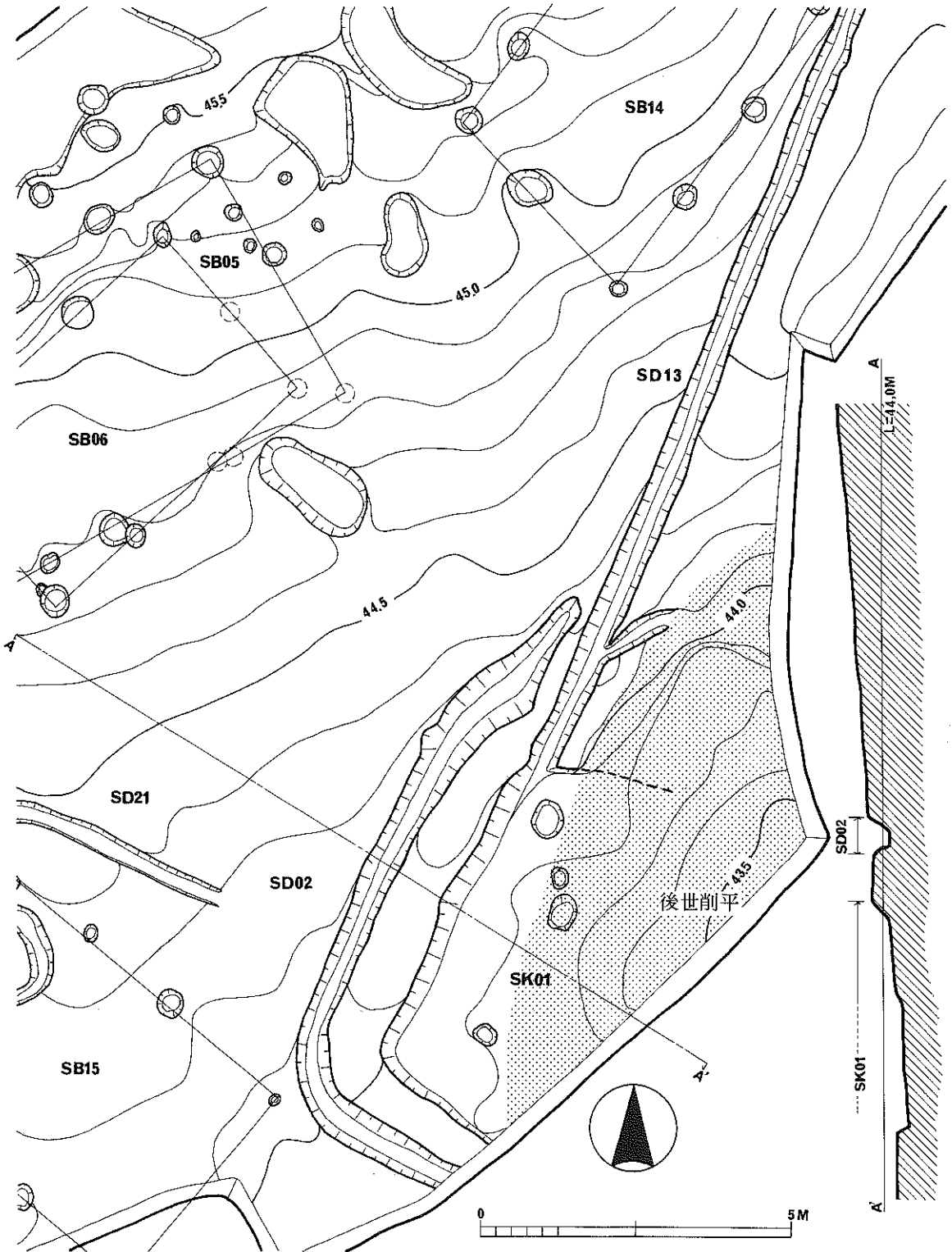

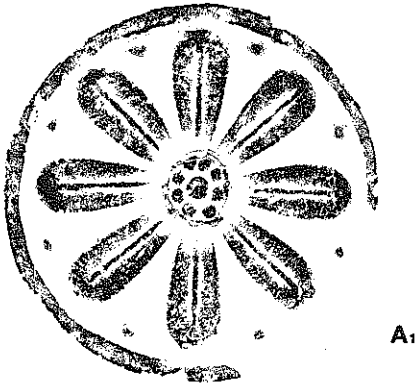

A₁

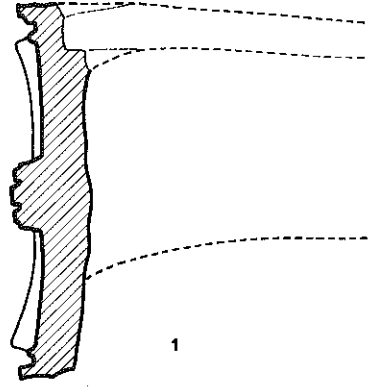

1

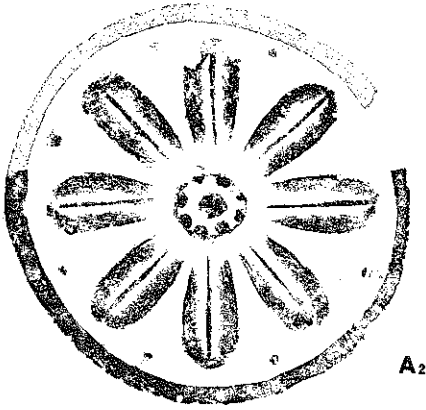

A₂

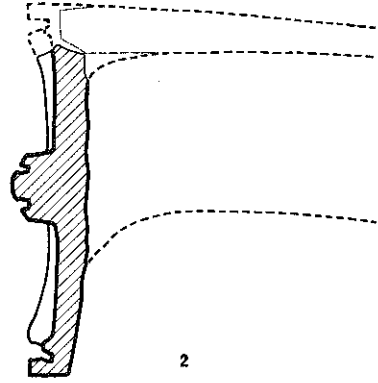

2

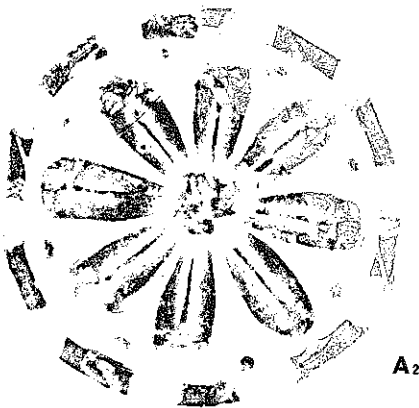

A₂

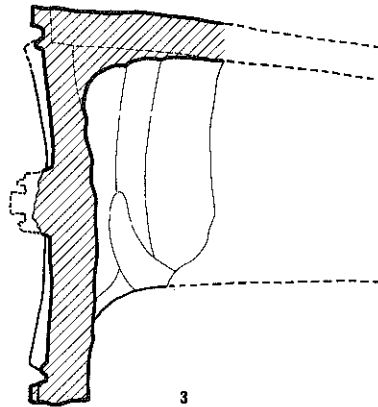

3



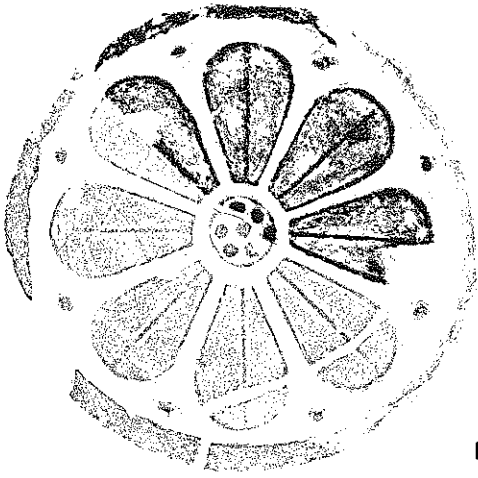

B

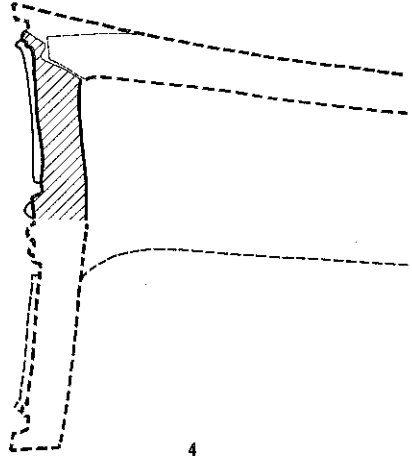

4

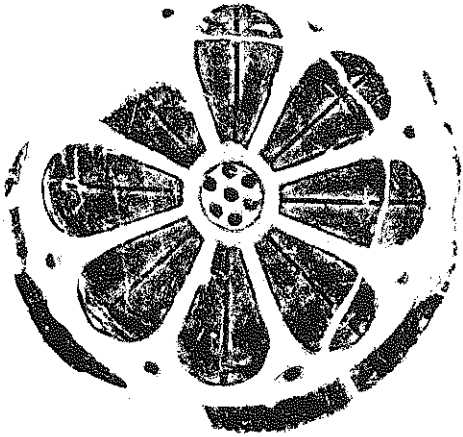

B

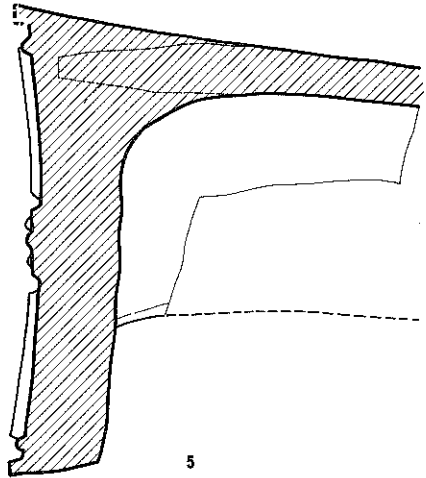

5

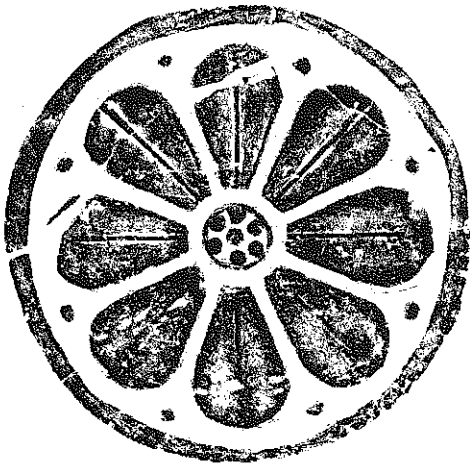

B

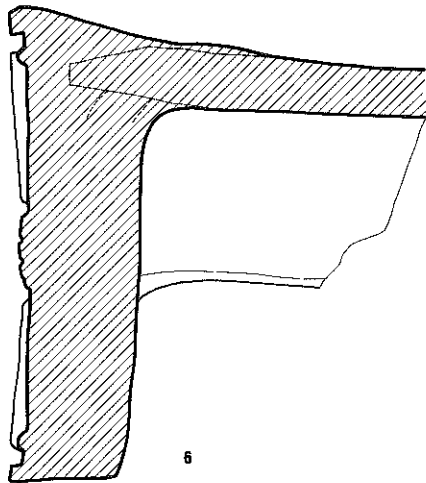

6

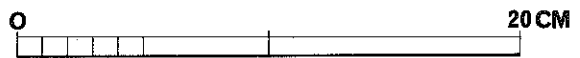

隼上り瓦窯跡

図版第一四 軒丸瓦拓影3 (D型式)

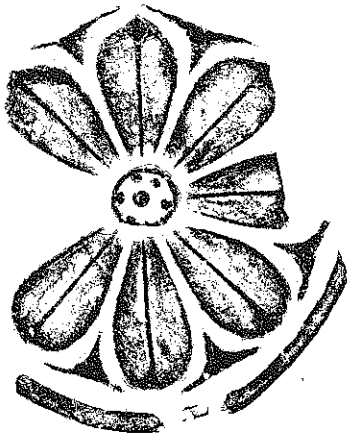

D

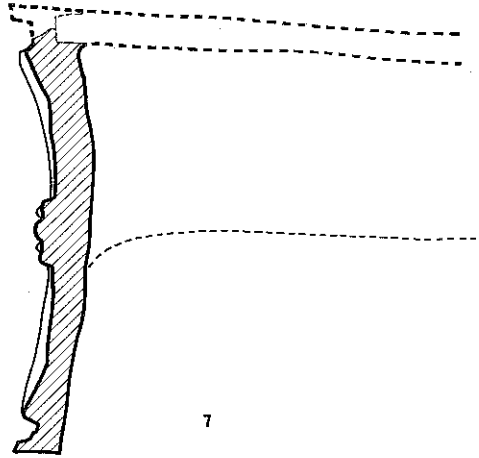

7

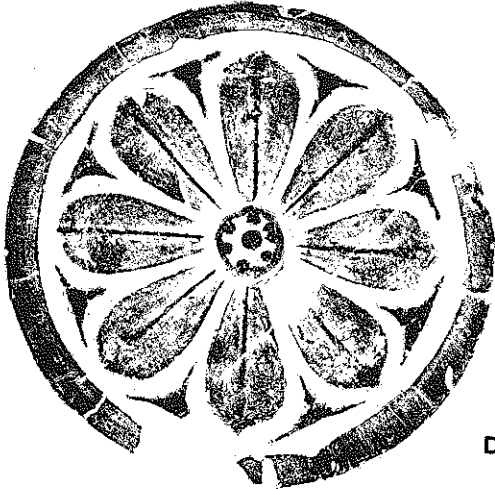

D

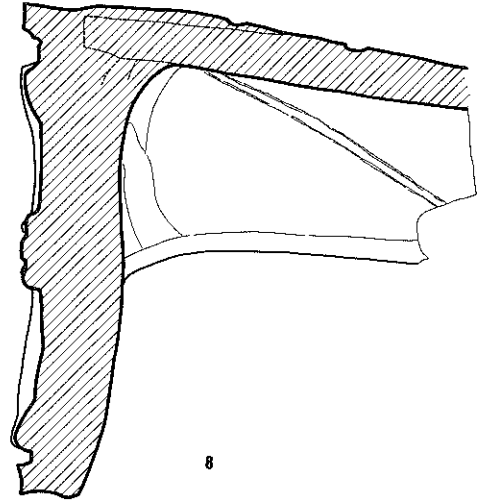

8

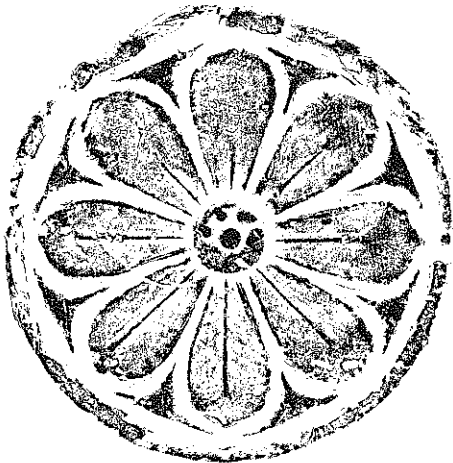

D

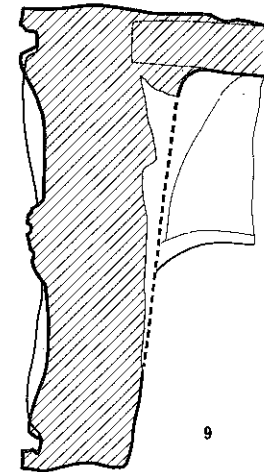

9

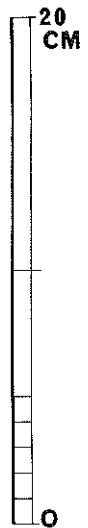

隼上り瓦窯跡

図版第一五 軒丸瓦拓影4 (C・E型式)

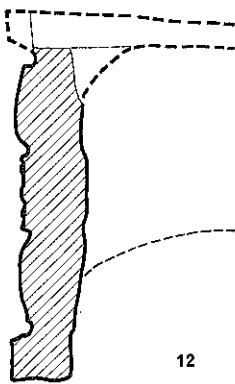
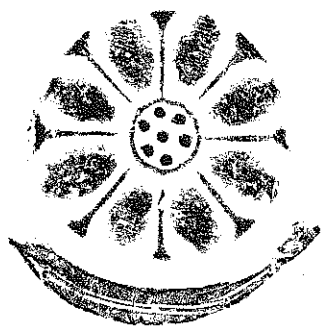
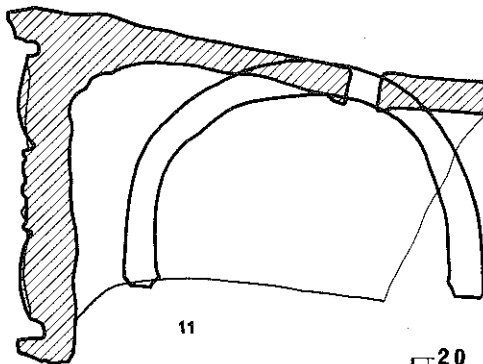
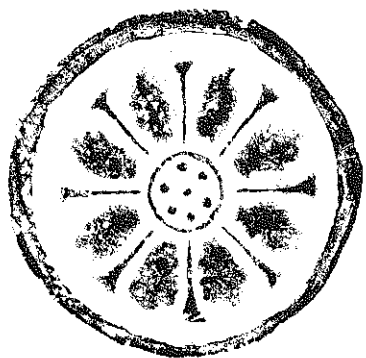
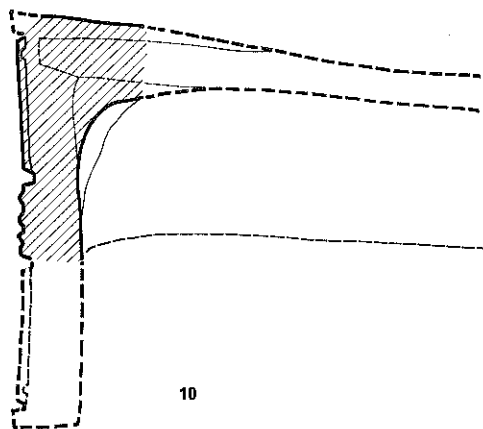
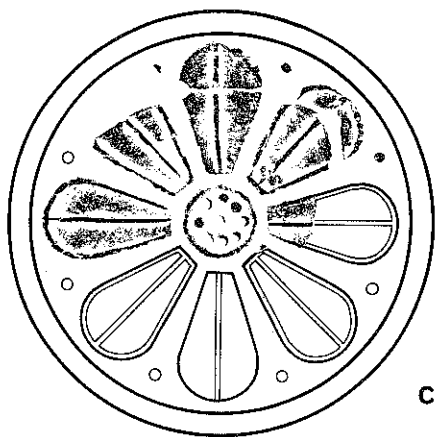

隼上り瓦窯跡

図版第一六 平瓦拓影1 (I類)

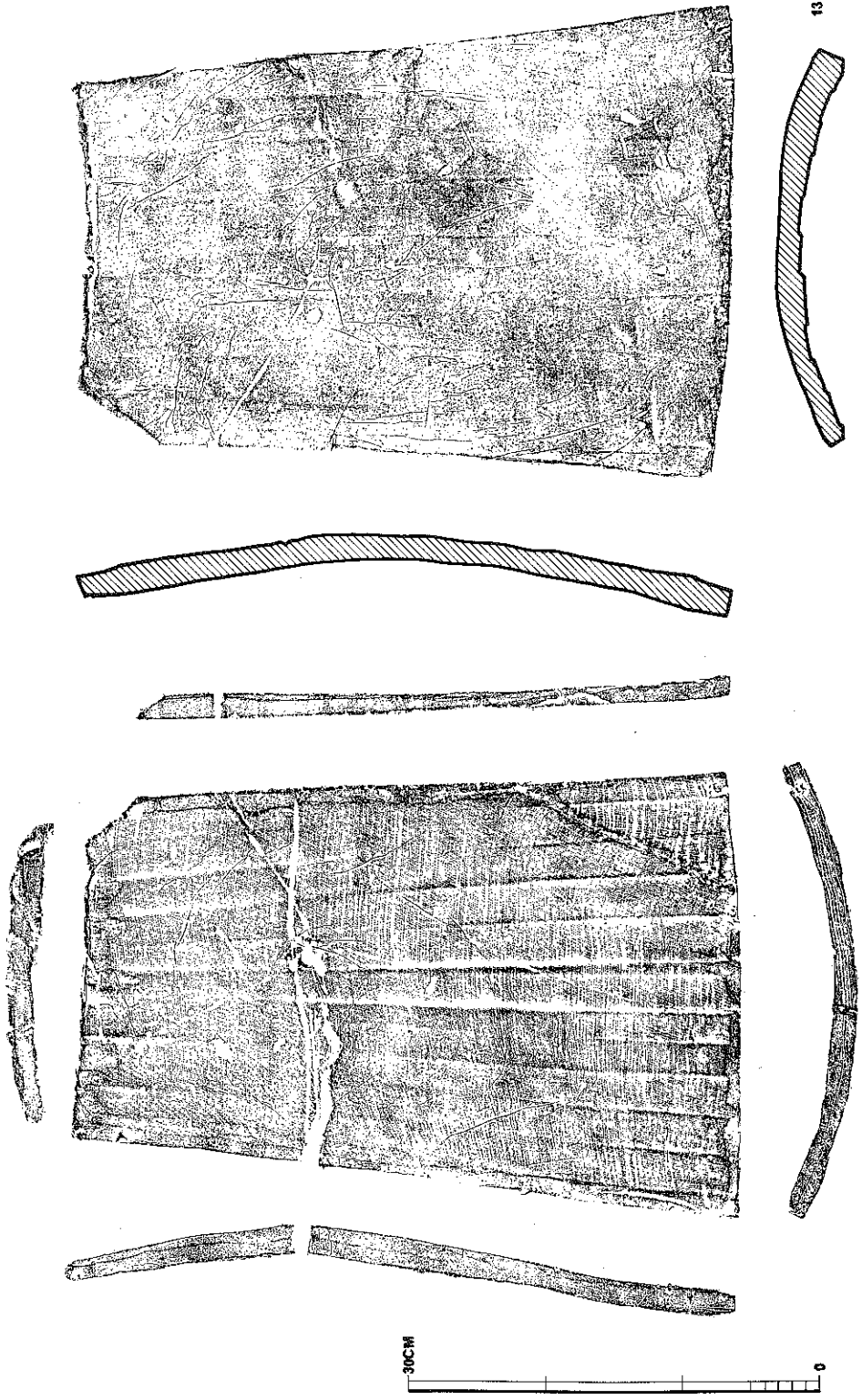

隼上り瓦窯跡

図版第一七 平瓦拓影2 (I類)

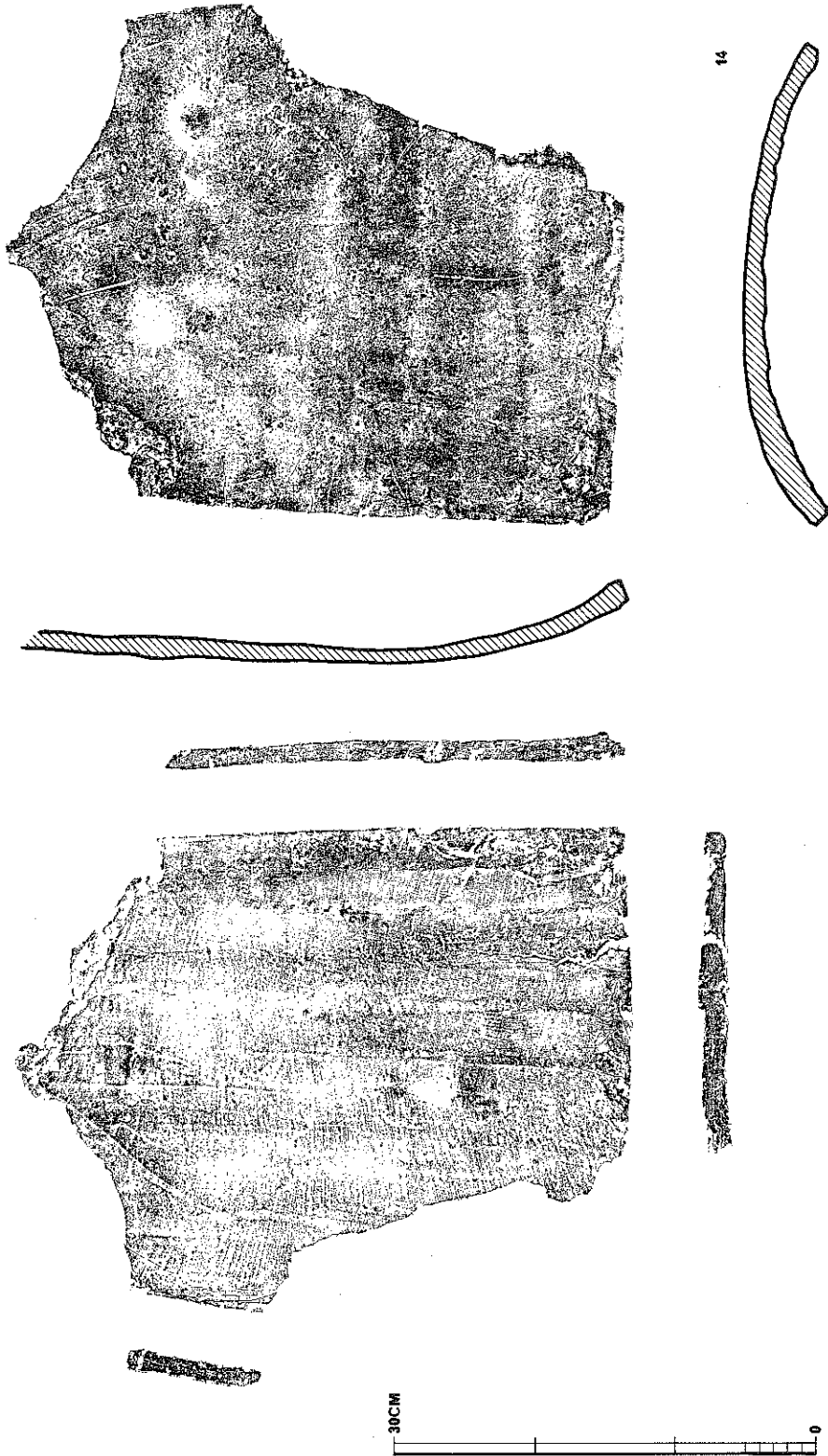

隼上り瓦窯跡

図版第一八 平瓦拓影3 (Ⅱ類)

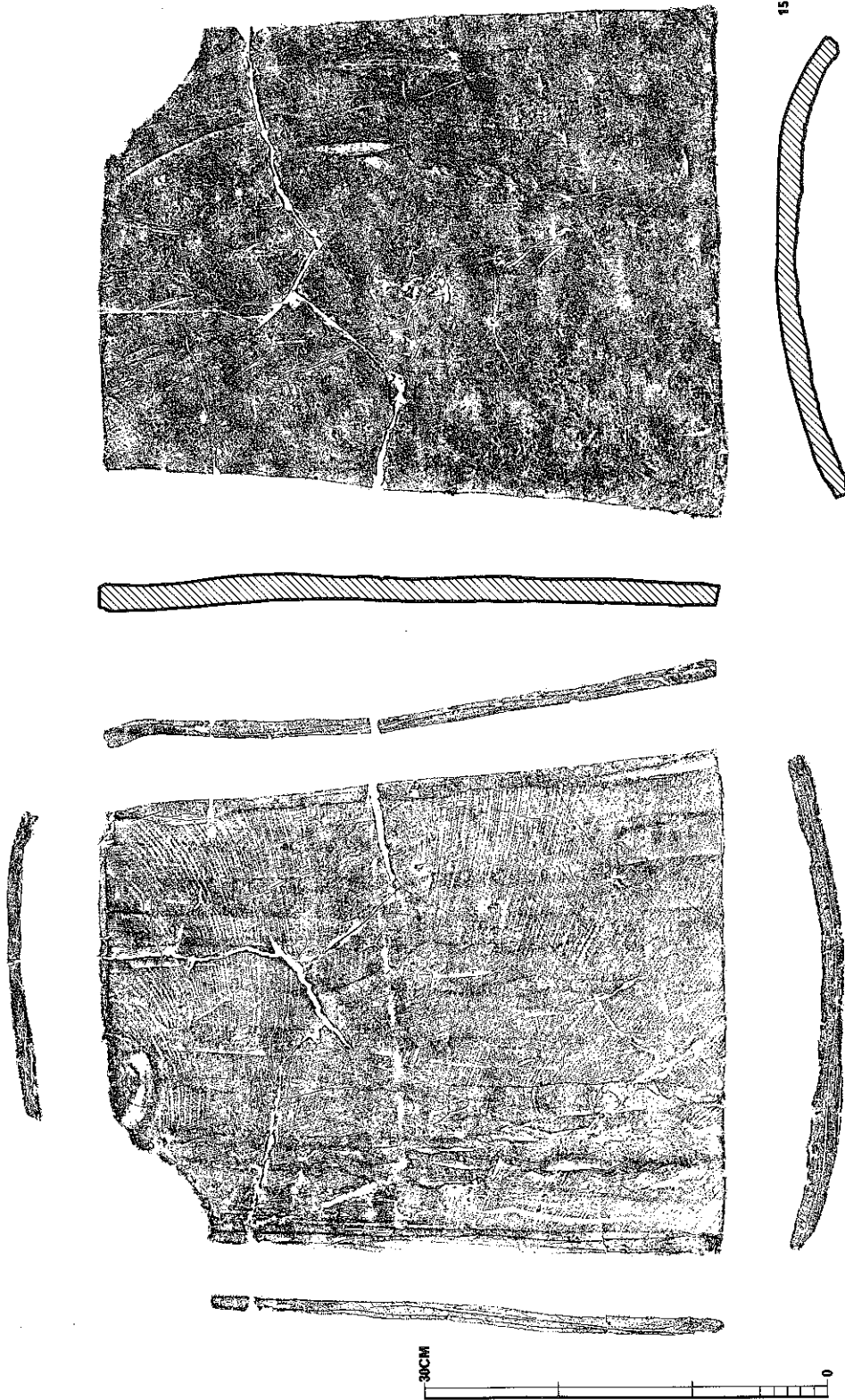

隼上り瓦窯跡

図版第一九 平瓦拓影4 (Ⅱ類)

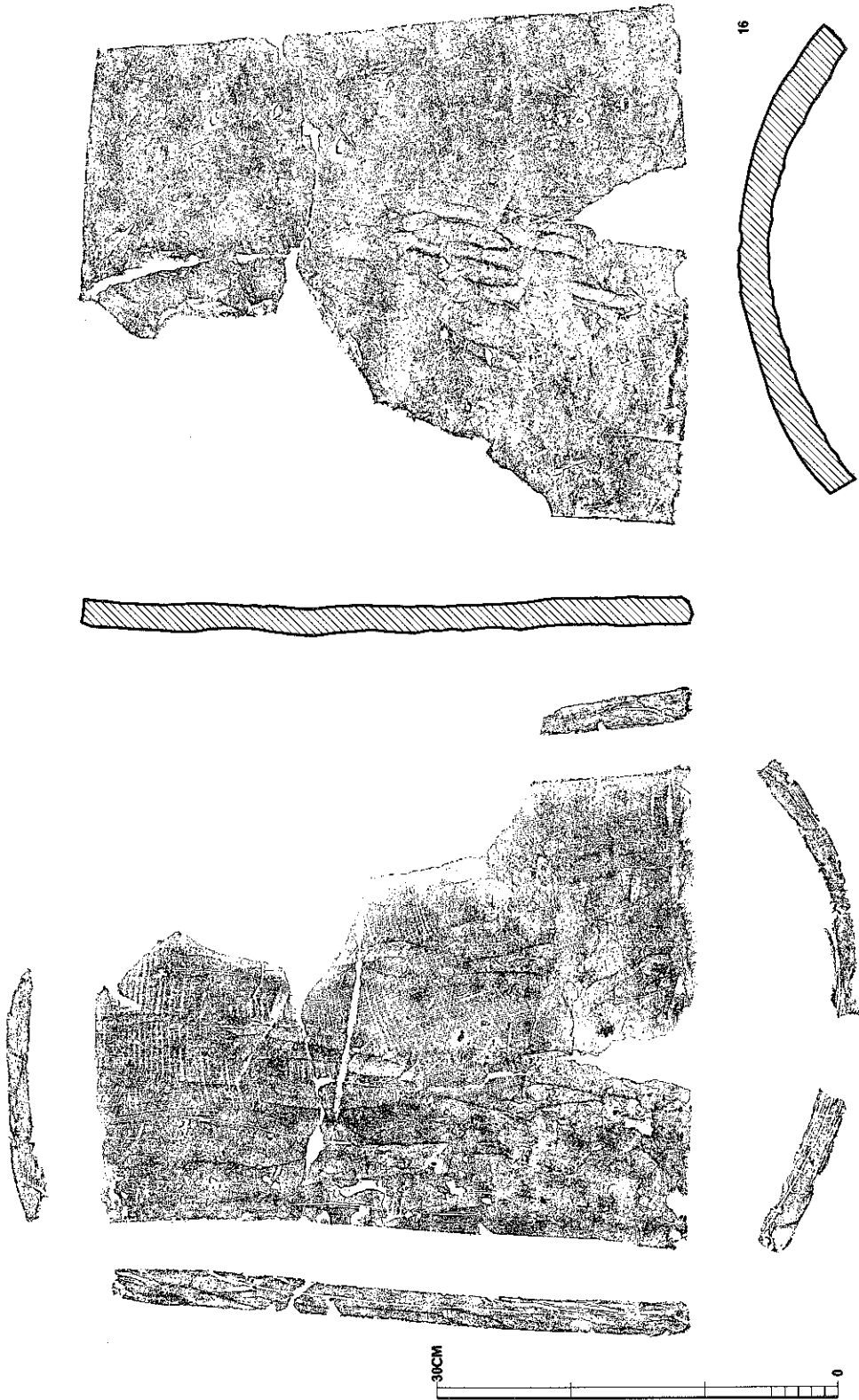

隼上り瓦窯跡

図版第二〇 平瓦拓影5 (Ⅲ類)

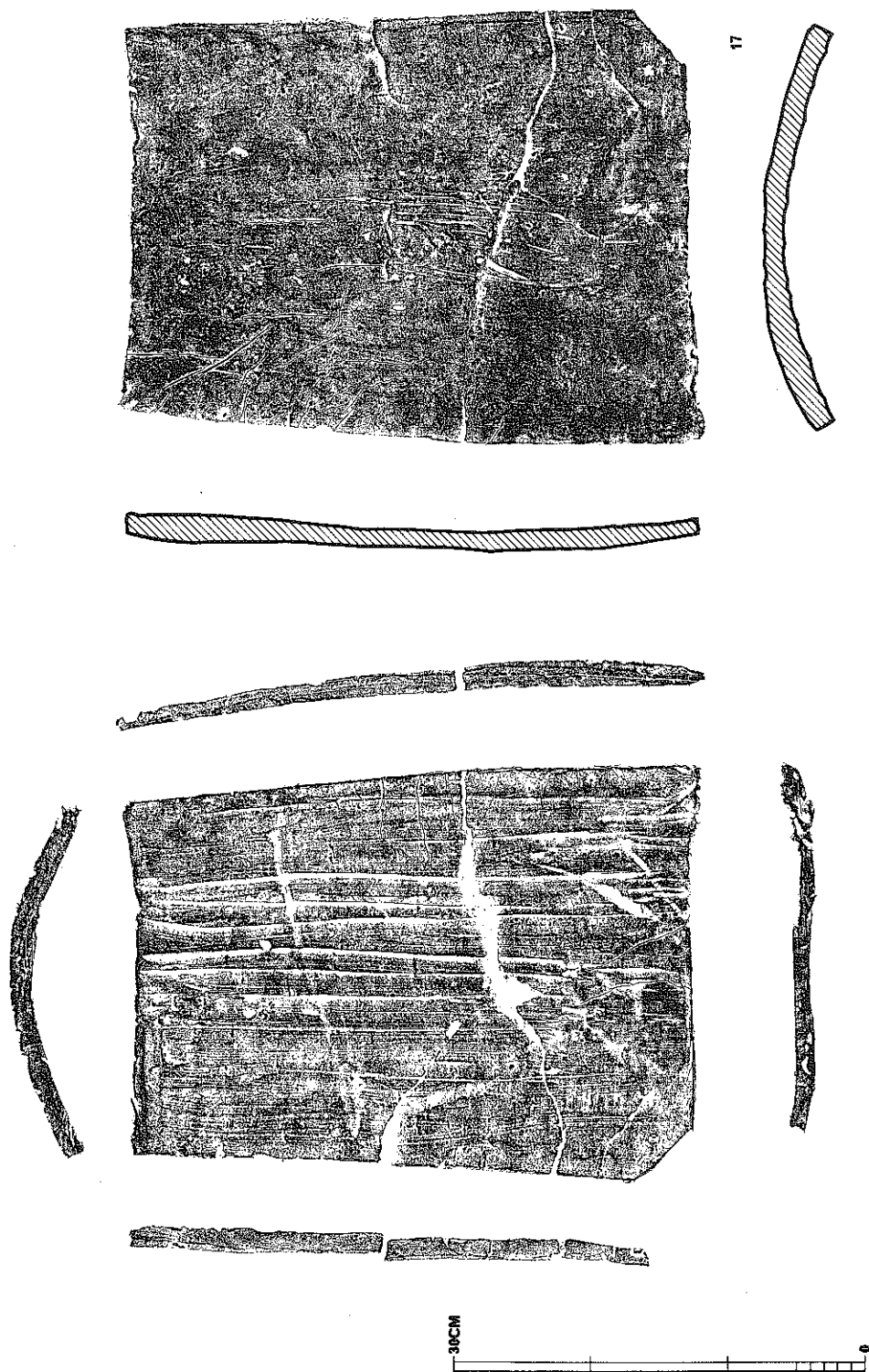

隼上り瓦窯跡

図版第二 平瓦拓影 6 (Ⅲ類)

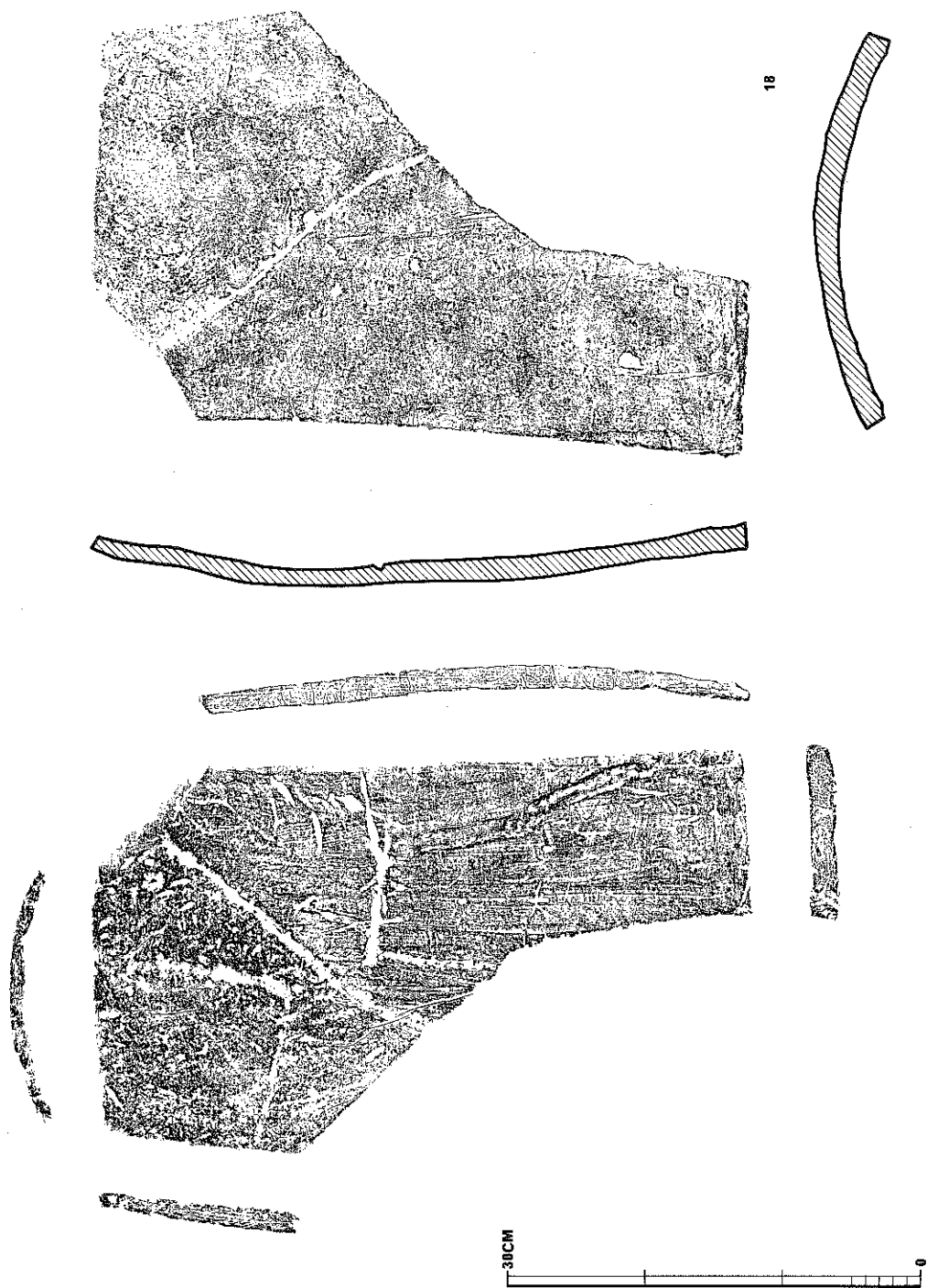

隼上り瓦窯跡

図版第三 平瓦拓影7 (Ⅲ類)

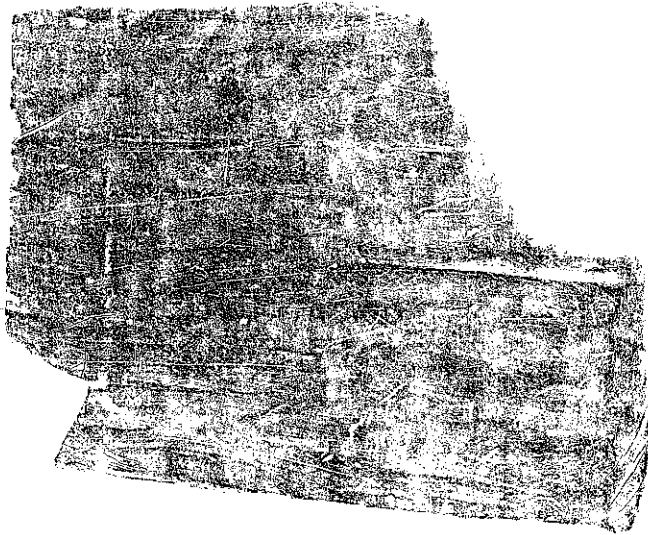
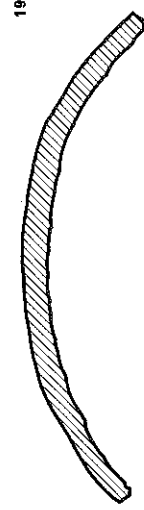

隼上り瓦窯跡

図版第三 平瓦拓影 8 (Ⅲ・Ⅳ類)

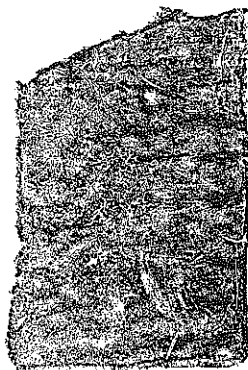
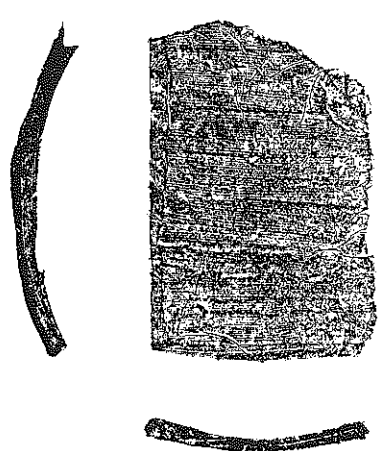

20

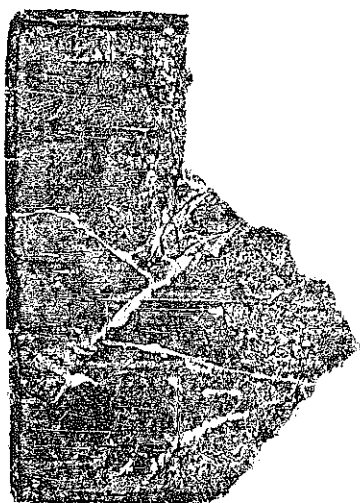
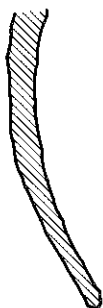

21

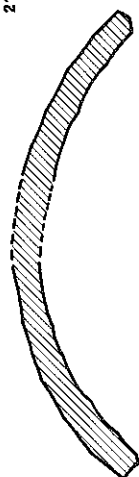

30CM



隼上り瓦窯跡

図版第二四 平瓦拓影9 (粘土板継ぎ目)

22

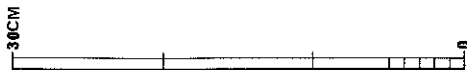
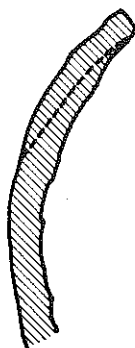

隼上り瓦窯跡

図版第二五 平瓦拓影10 (隅切り平瓦)

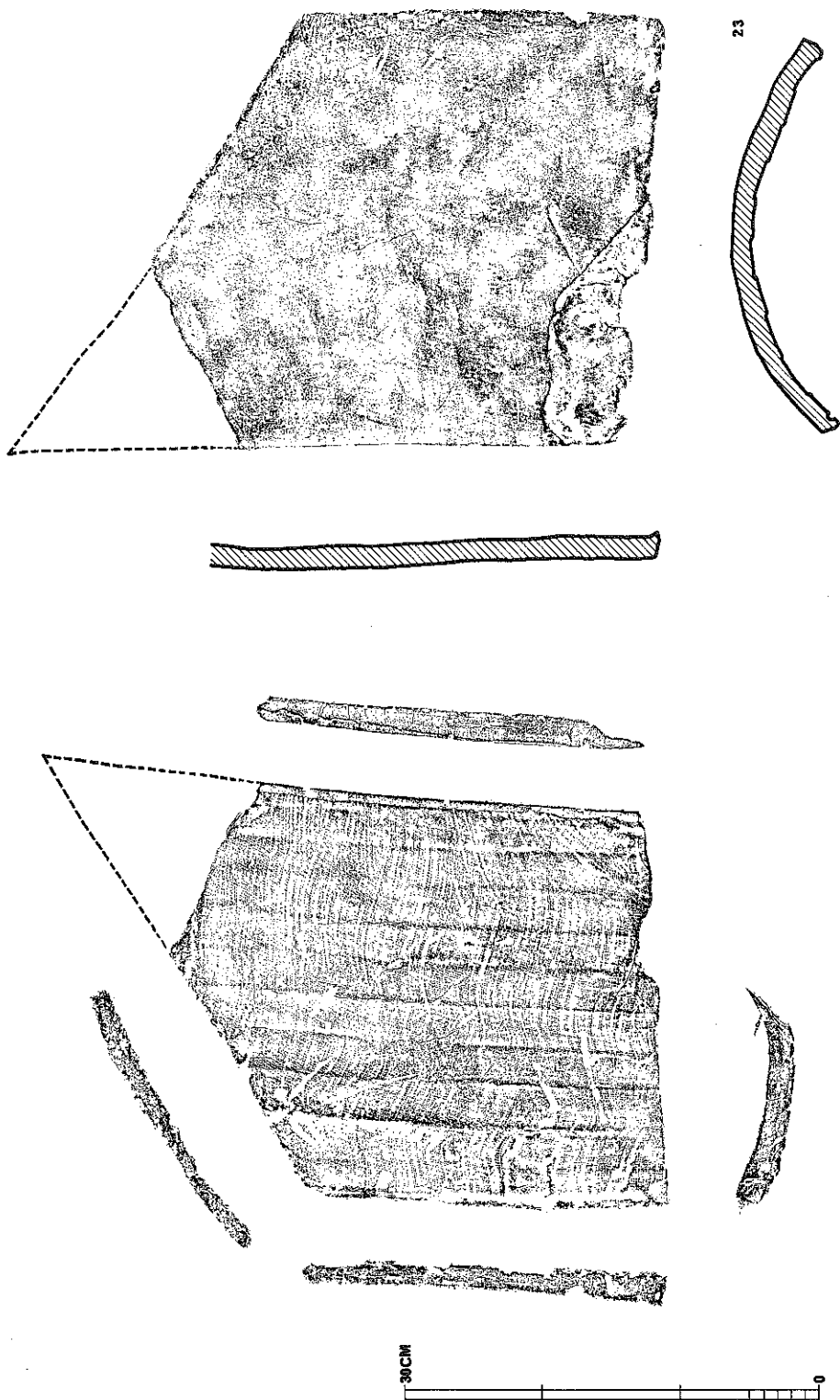

隼上り瓦窯跡

図版第二六 丸瓦拓影1 (I類)

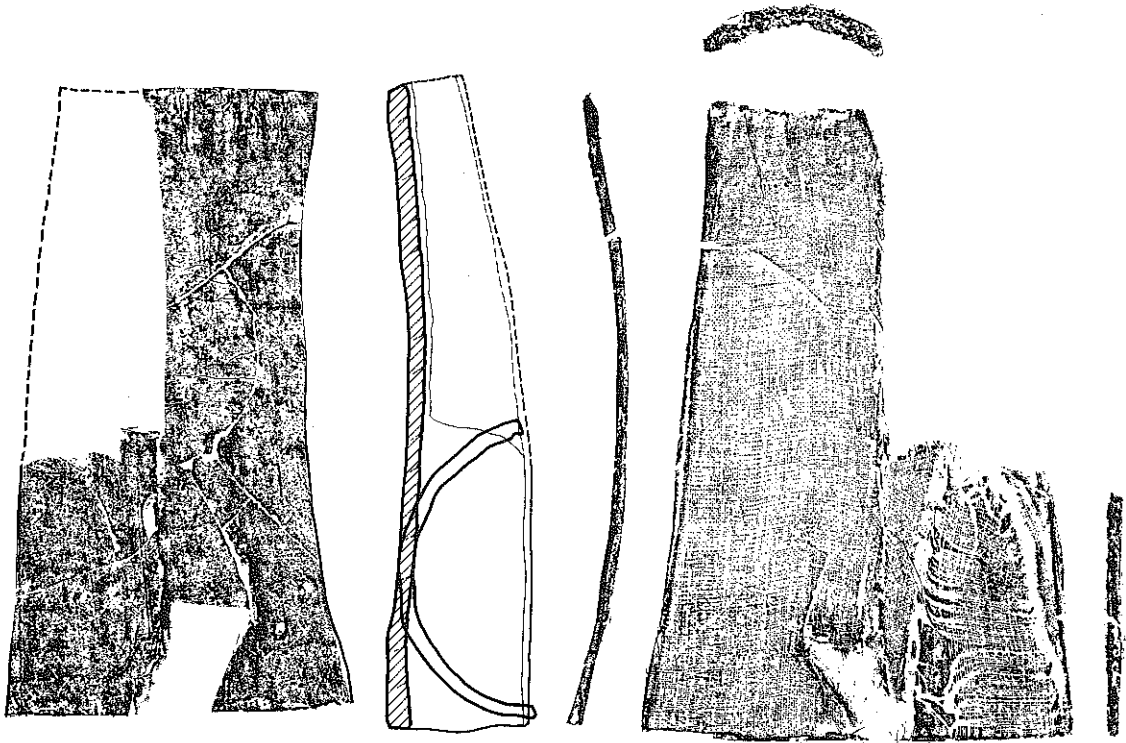

24

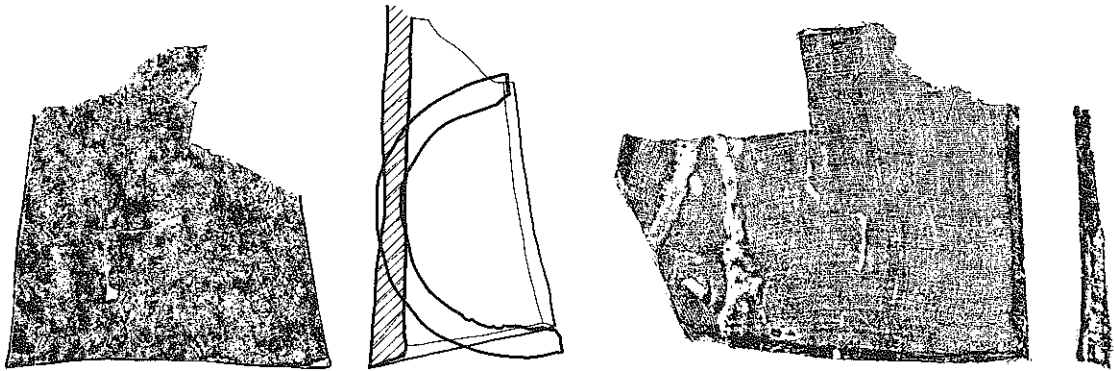

25

0 20CM

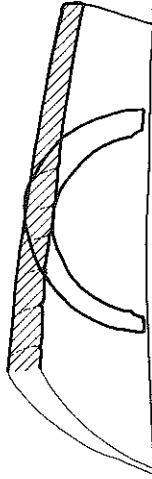
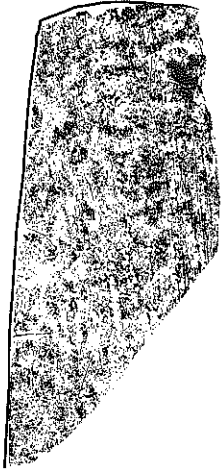

26

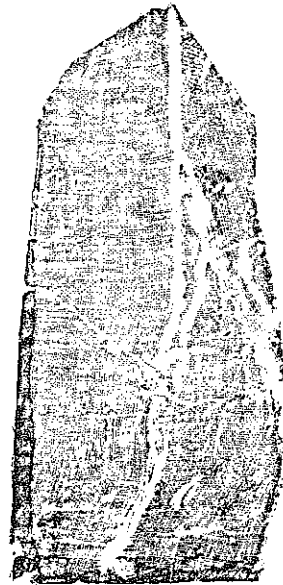
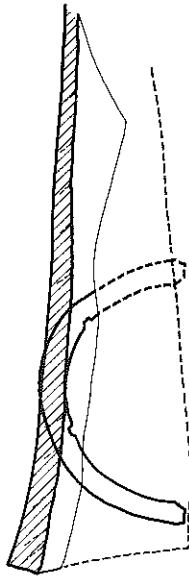

27

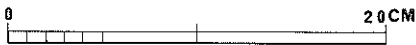

隼上り瓦窯跡

図版第二八 丸瓦拓影3 (I類:28、II類:29)

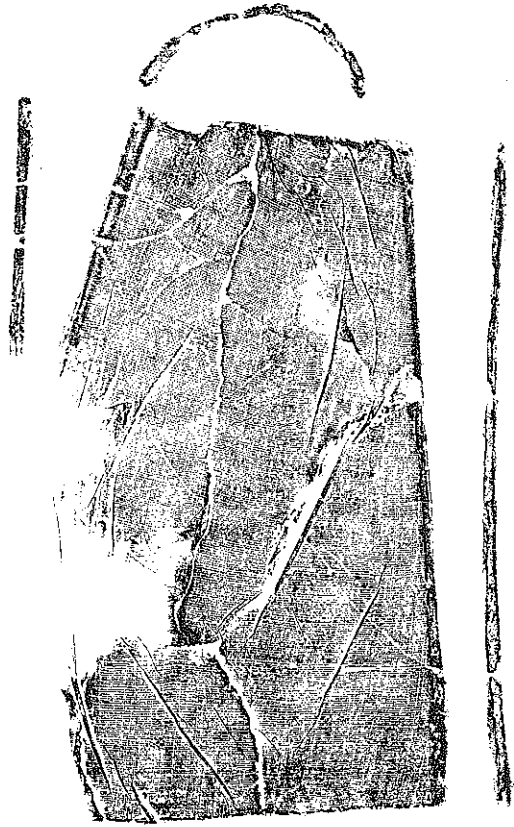
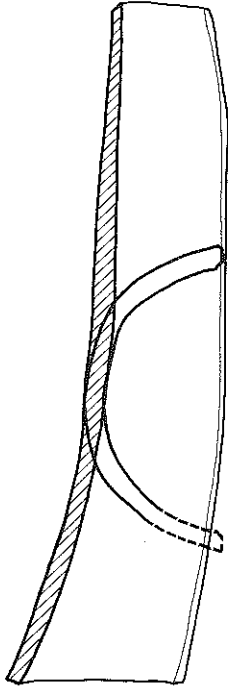

28

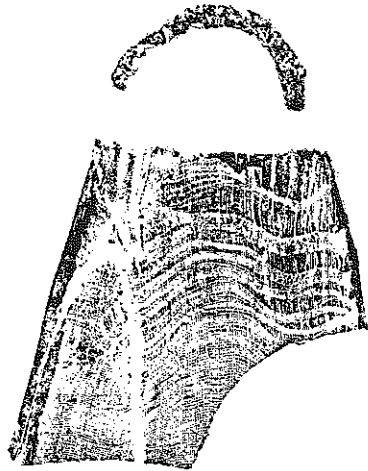
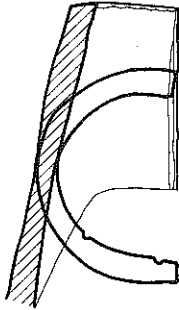
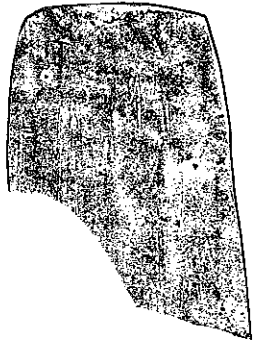

29

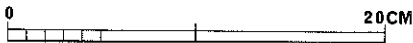

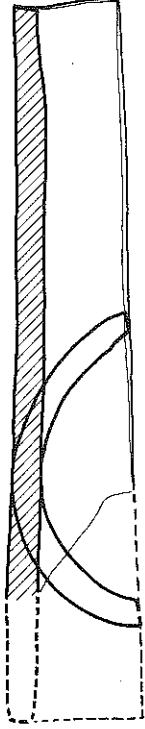
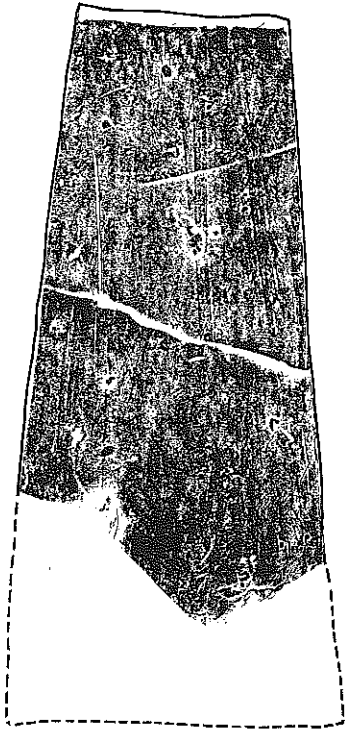

30

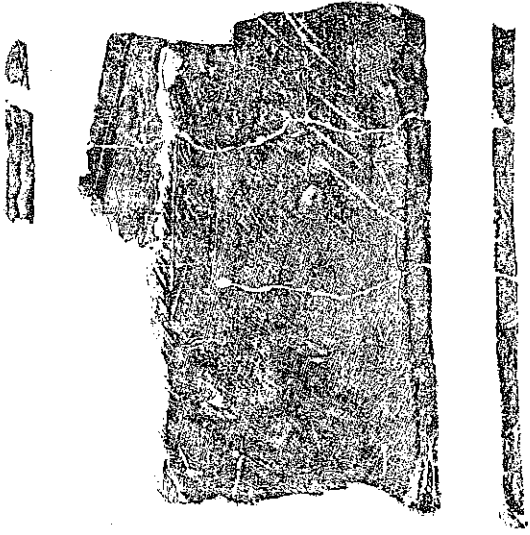
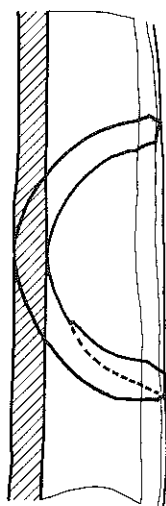

31

0 20CM

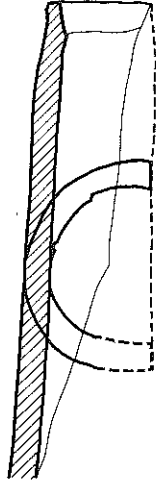

32

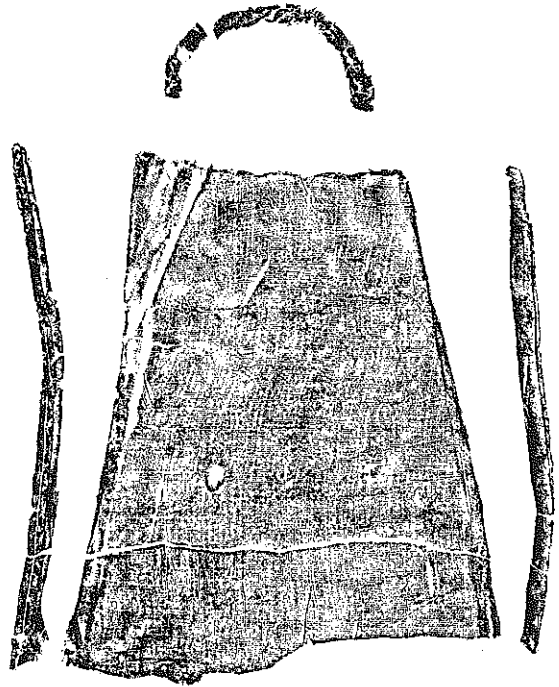
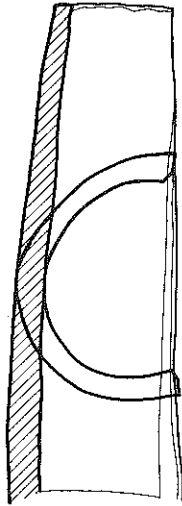
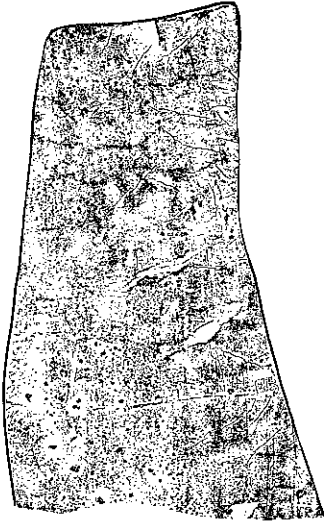

33

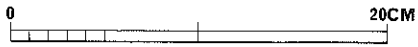

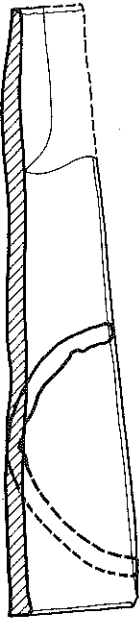
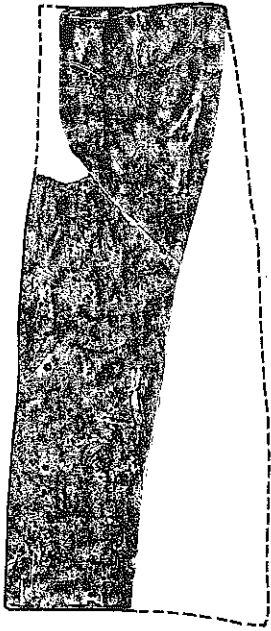

34

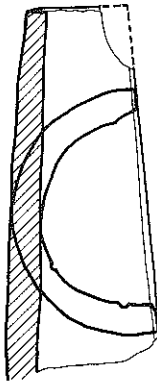

35

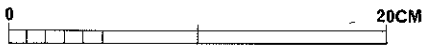

隼上り瓦窯跡

図版第三二 土器実測図1 (1号窯最終床面・1号窯SD01)

1号窯最終床面

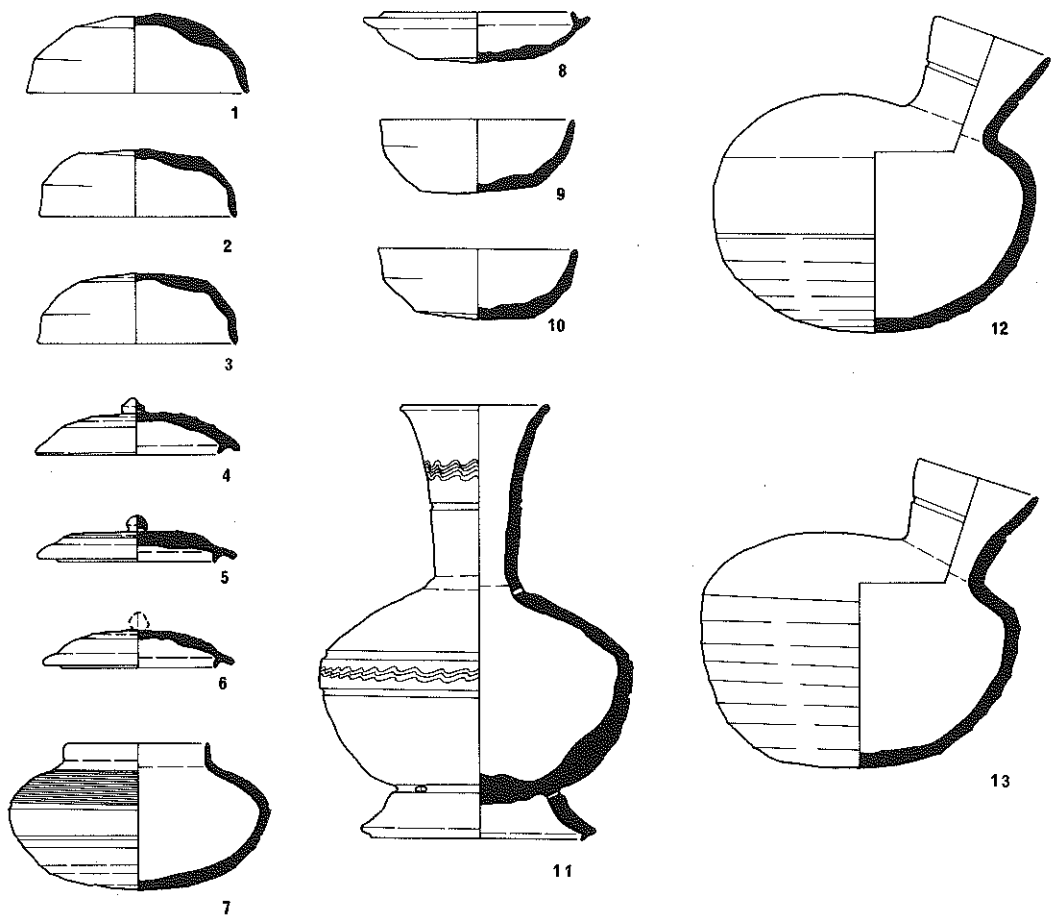

1号窯SD01

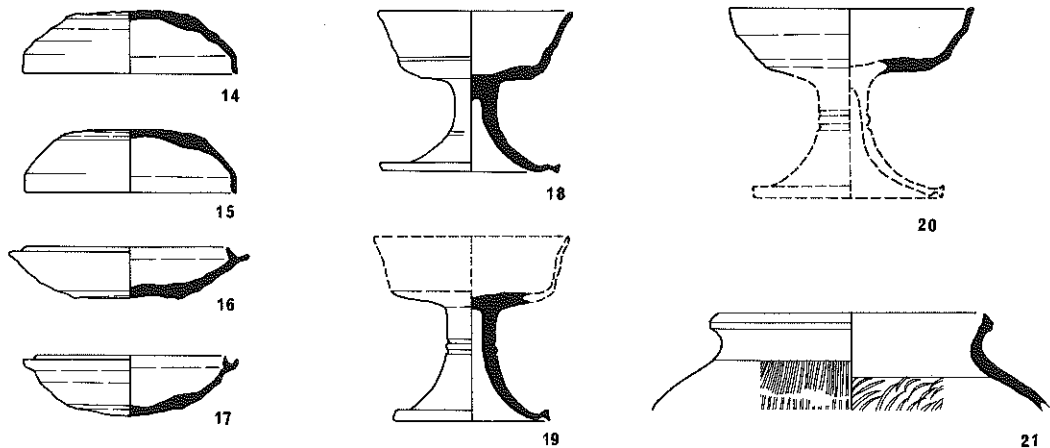

隼上り瓦窯跡

1号窯灰原

図版第三三
土器実測図2



22



35

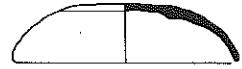

48



23

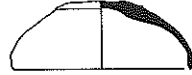

36



49



24



37



50

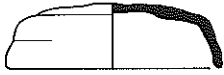

25



38



51

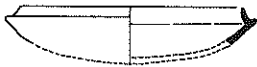

26

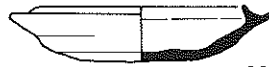

39



52

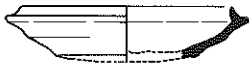

27



40

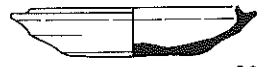

53



28



41



54



29

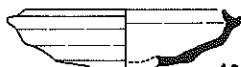

42



55



30

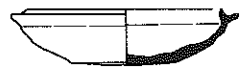

43



56



31



44

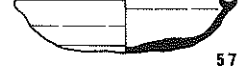

57



32



45



58



33



46

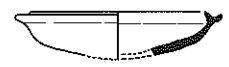

59



34



47



60



集上り瓦窯跡

1号窯灰原

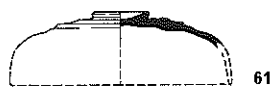

61



62

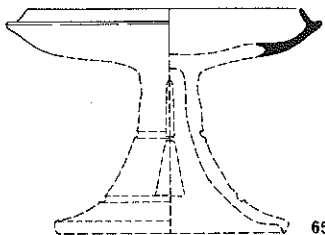

65

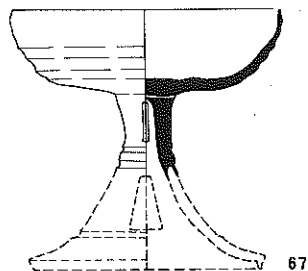

67



63

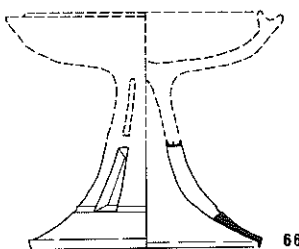

66

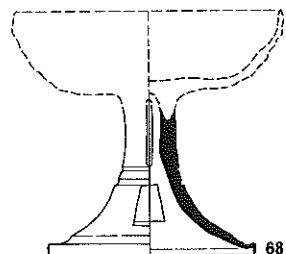

68

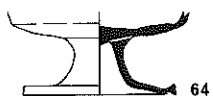

64

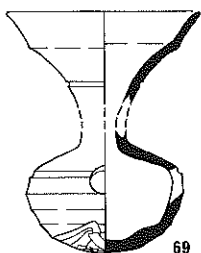

69

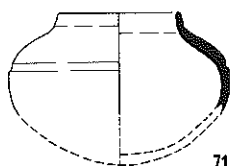

71

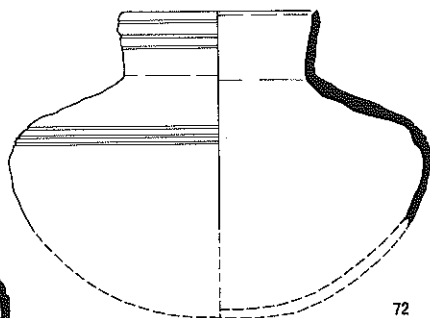

72

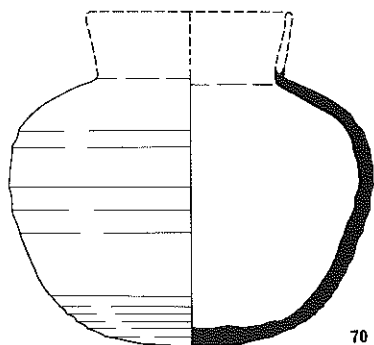

70

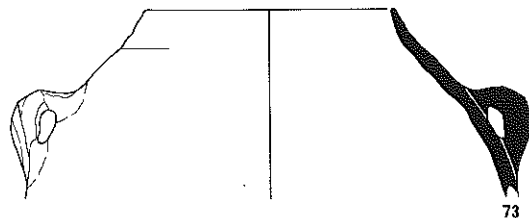

73

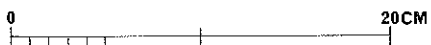

隼上り瓦窯跡

2号窯最終床面

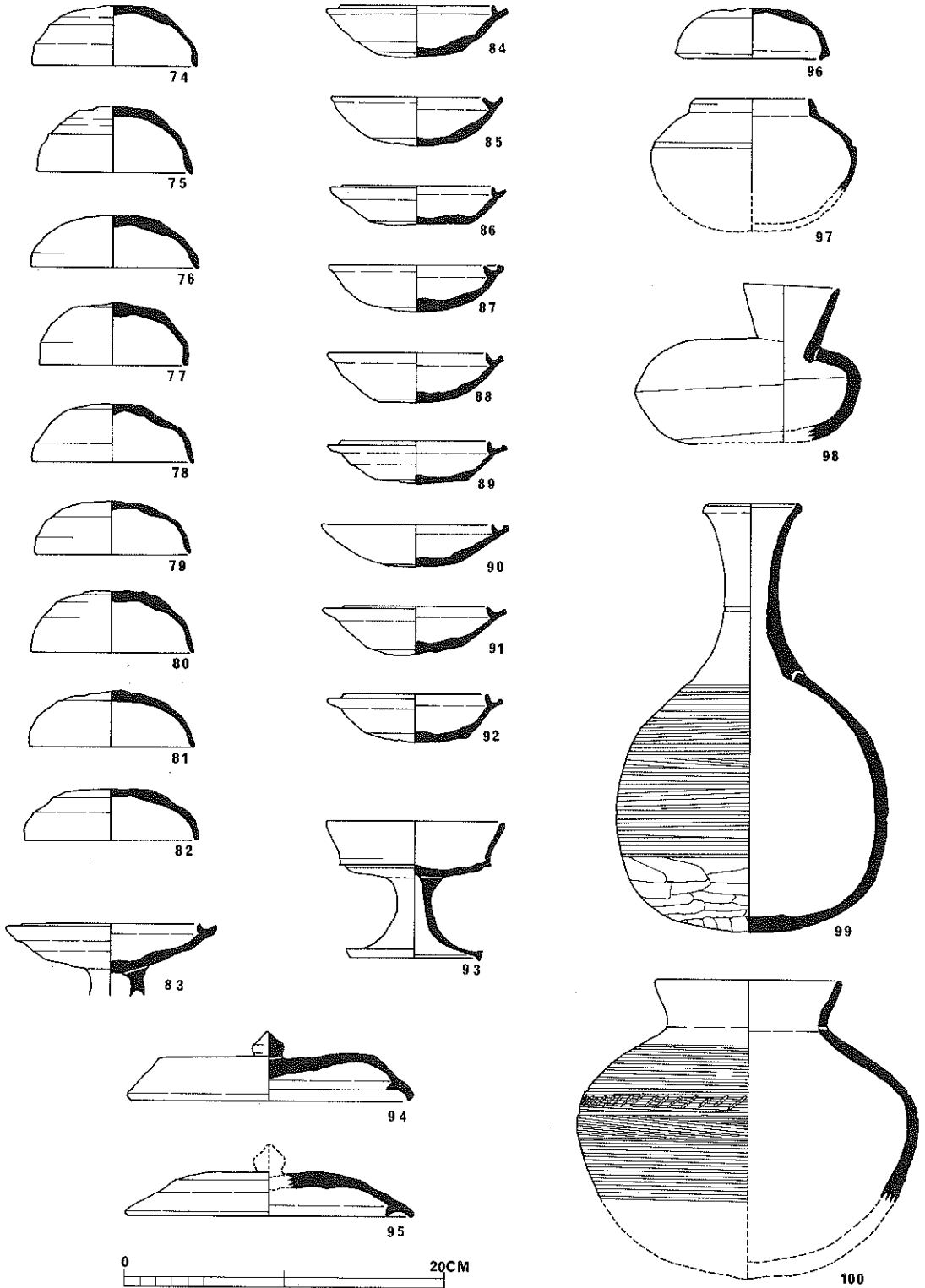

隼上り瓦窯跡

2号窯灰原

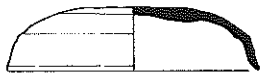

101

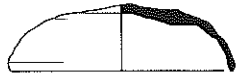

112



123

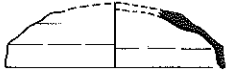

102



113



124



103



114



125

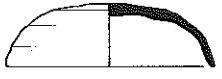

104



115



126



105

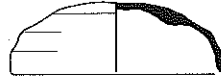

116

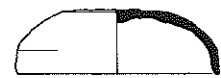

127

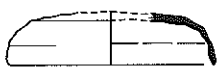

106



117

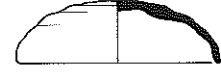

128

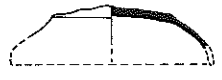

107



118



129



108

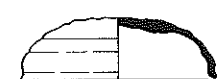

119

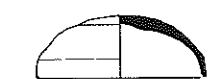

130

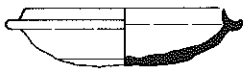

109



120

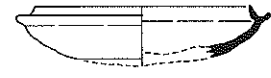

131

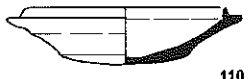

110



121



132



111



122

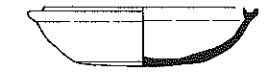

133

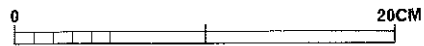

隼上り瓦窯跡

2号窯灰原

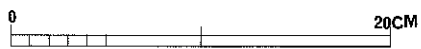
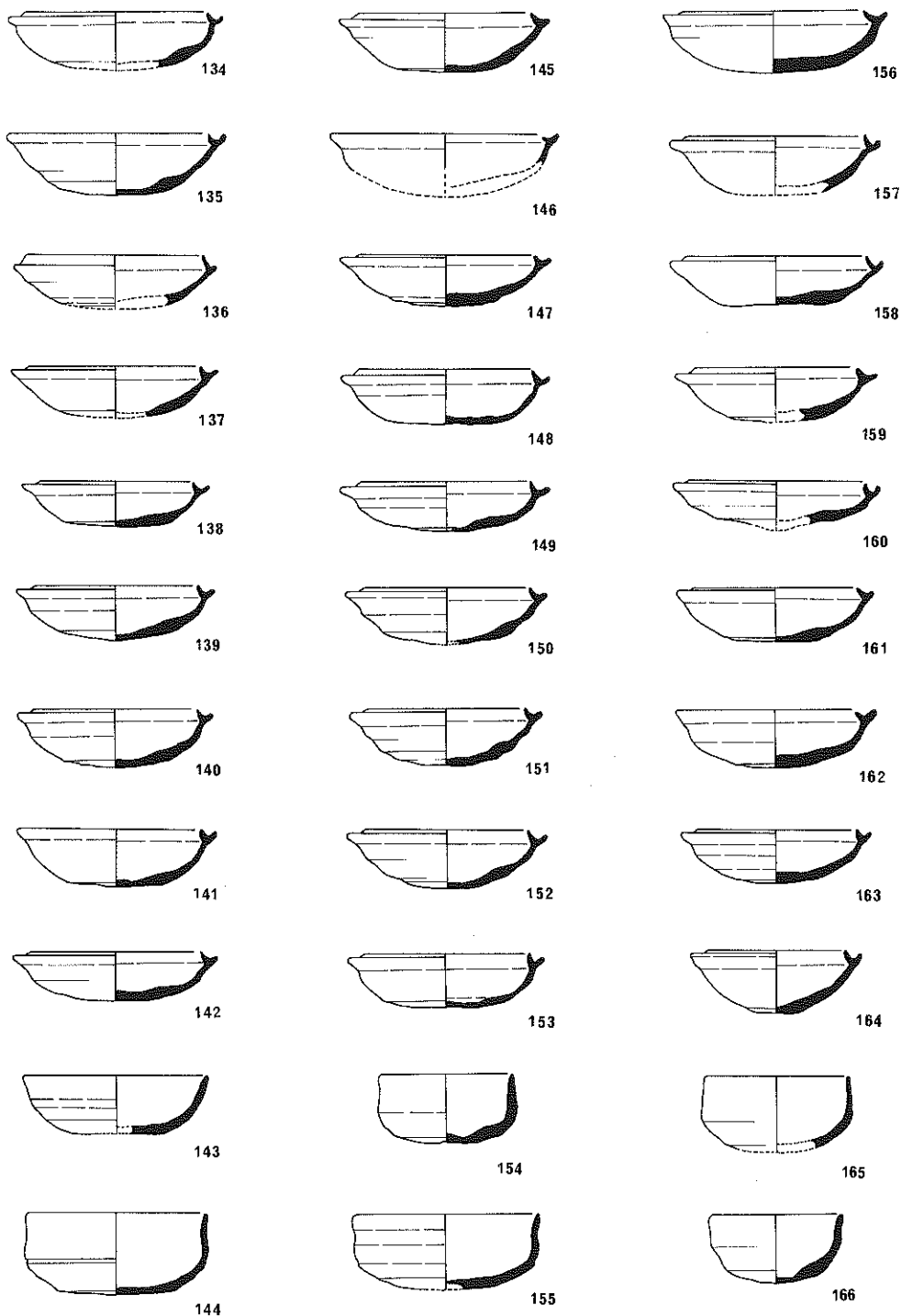

図版第三七 土器実測図6

2号窯灰原

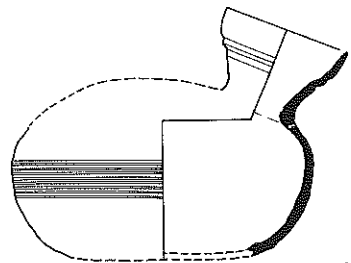
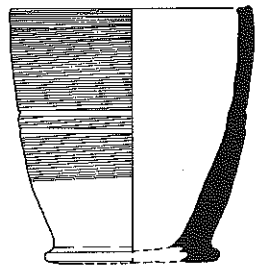
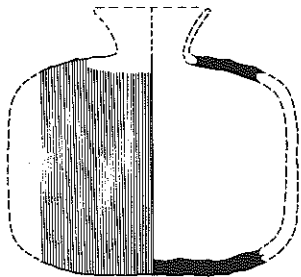
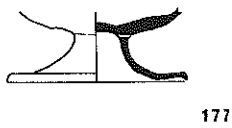
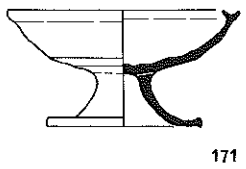
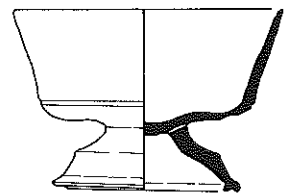
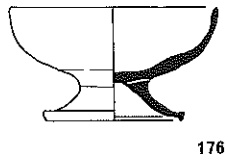
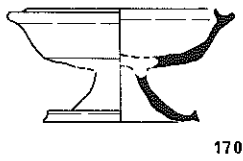
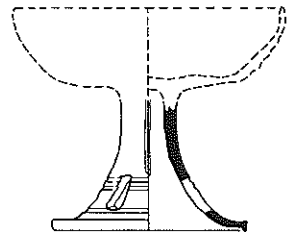
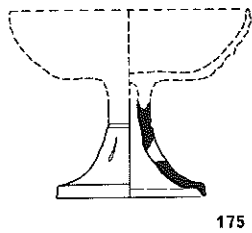
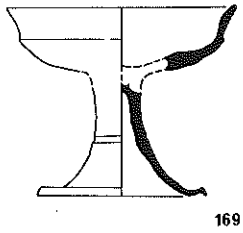
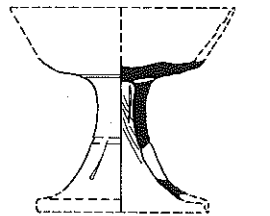
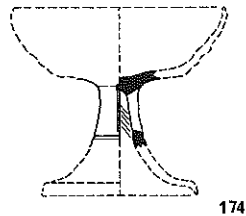
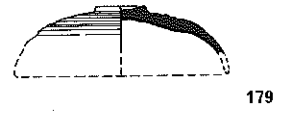
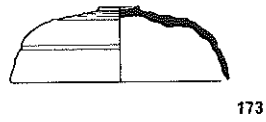
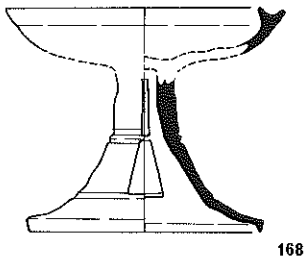
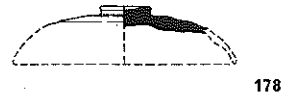
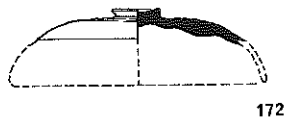
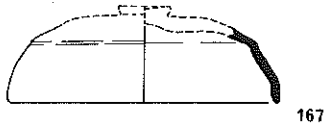

183

184

185

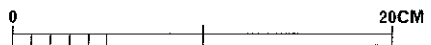

隼上り瓦窯跡

2号窯灰原

図版第三九 土器実測図 8

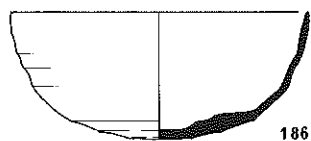

186

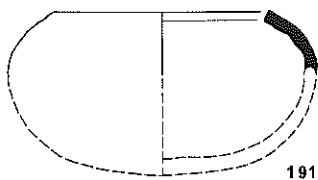

191

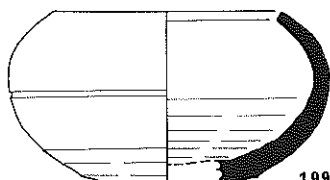

199

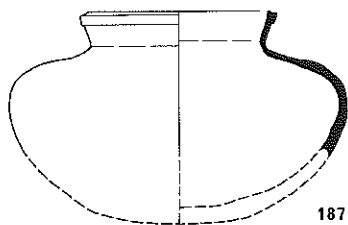

187



192

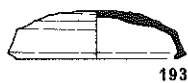

193

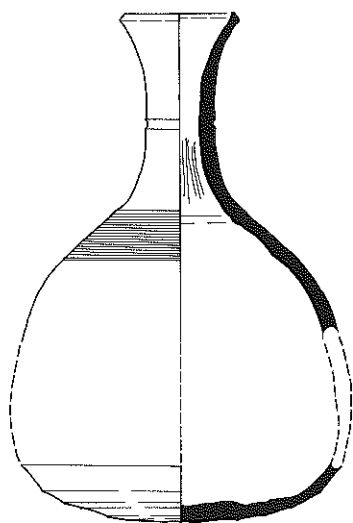

200

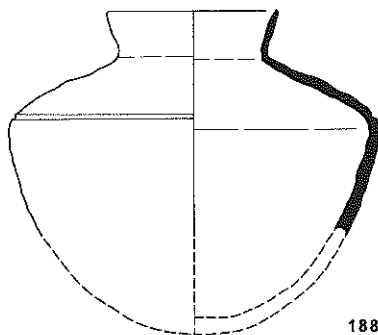

188

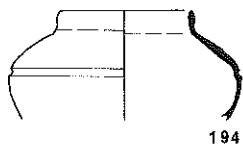

194

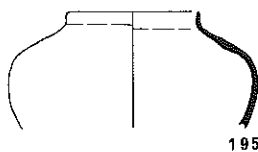

195

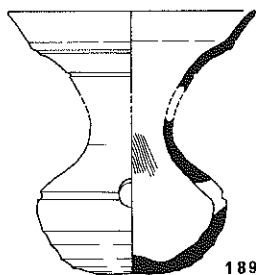

189

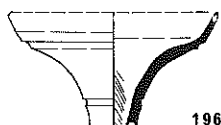

196

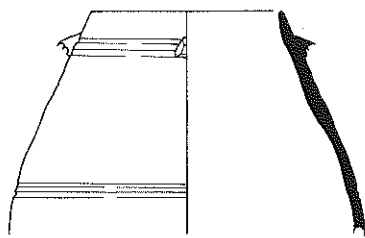

201

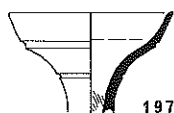

197

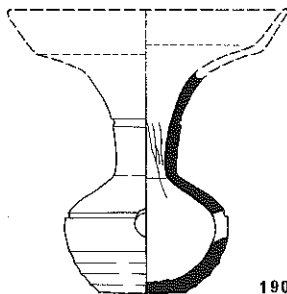

190

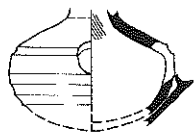

198

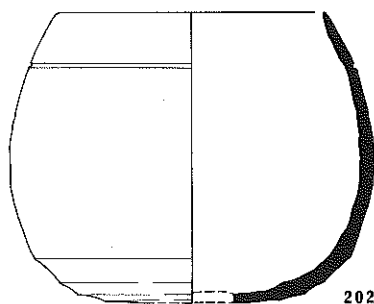

202



隼上り瓦窯跡

2号窯灰原

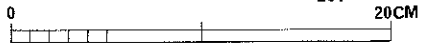
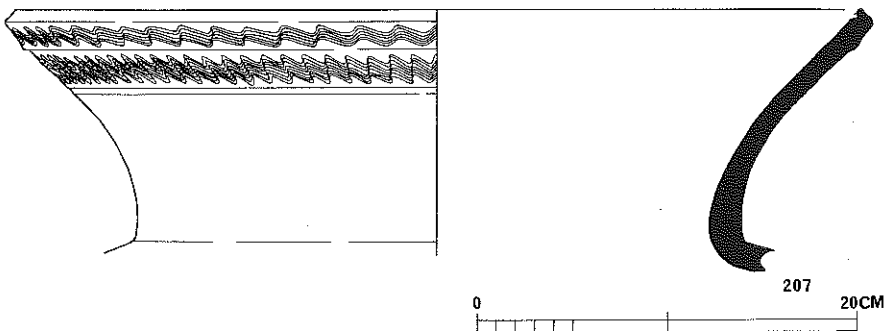
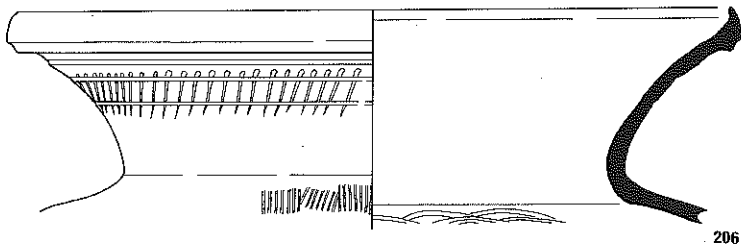
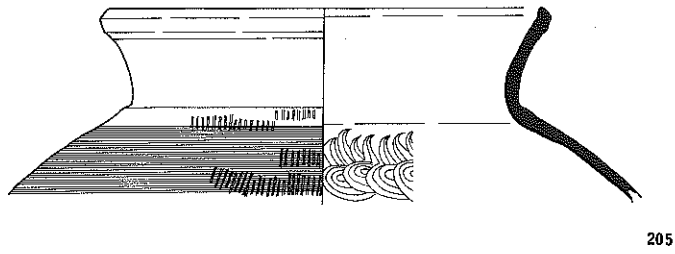
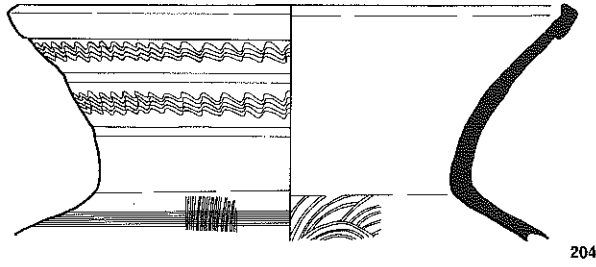
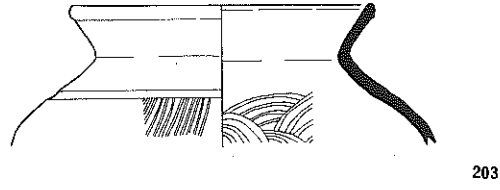

隼上り瓦窯跡

3号窯最終床面

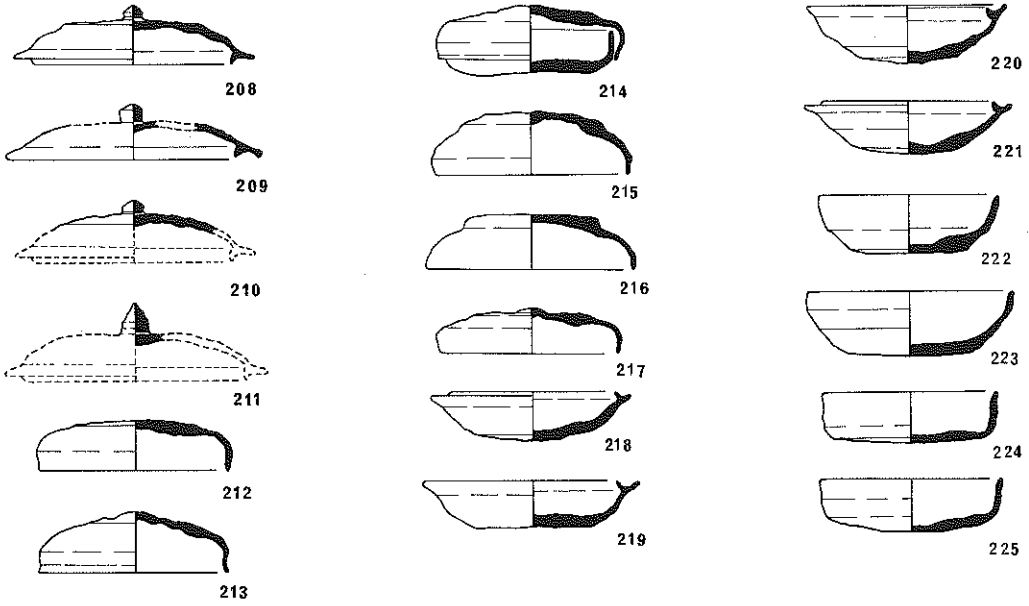

3号窯灰原

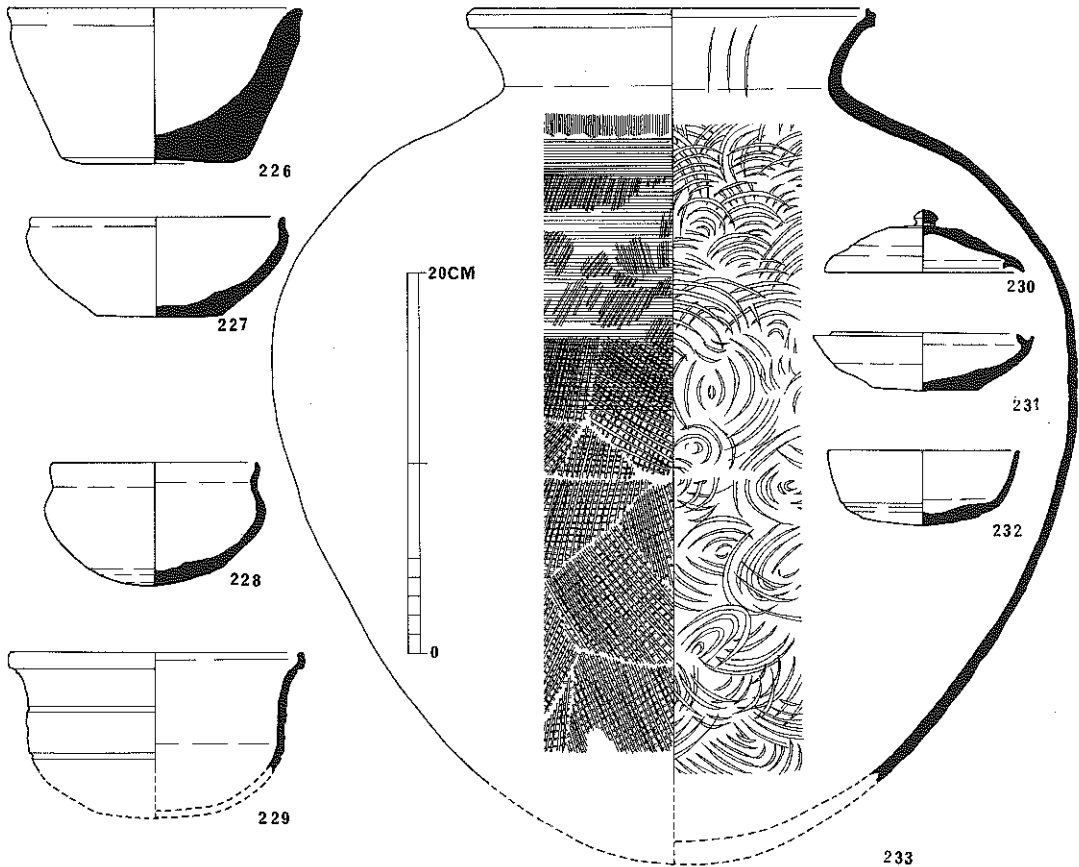

隼上り瓦窯跡

SK01

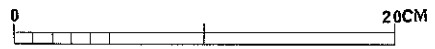
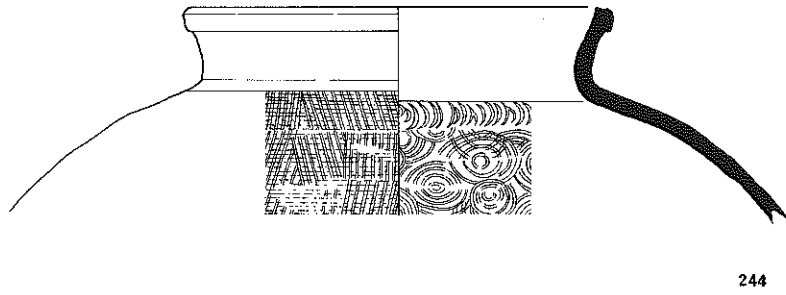
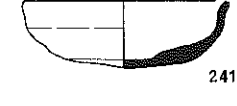
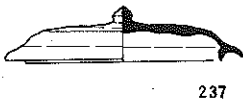
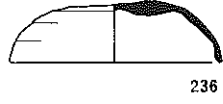
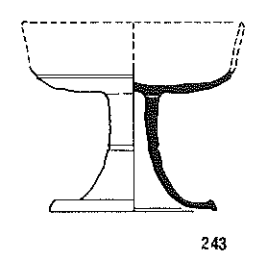
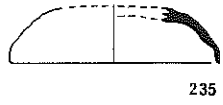
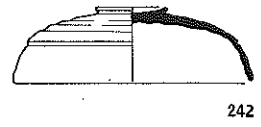
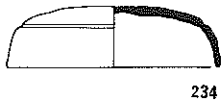

SD02

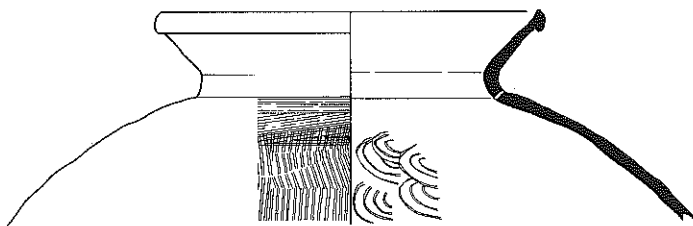
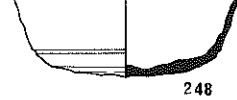
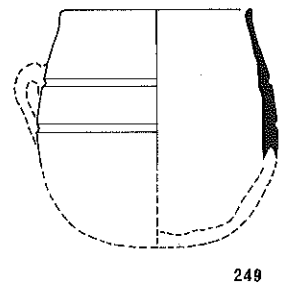
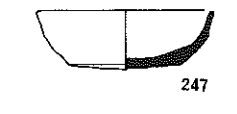
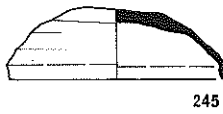

図版第四二 土器実測図11〔工房跡〕(第3トレンチSK01・SD02)

隼上り瓦窯跡

図版第四三 土器実測図12 (工房跡) (第3トレンチSK07・SK08・SX18・SX21)

SK07

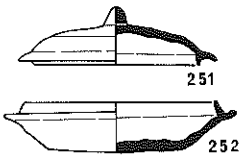

SK08

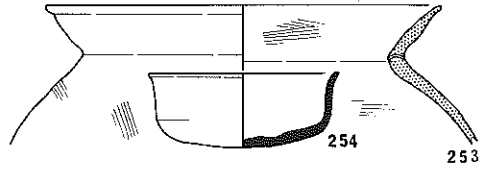

SD11

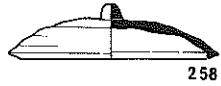
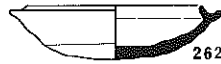
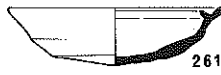
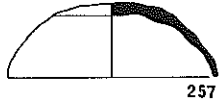
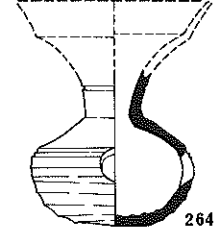
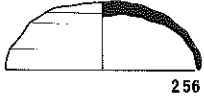
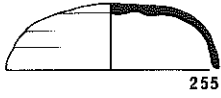

SX18

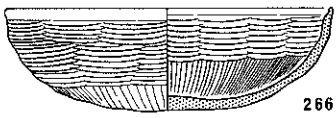
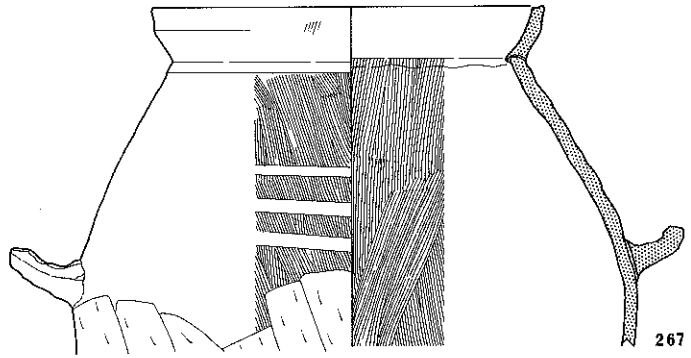
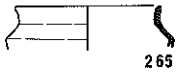

SK21

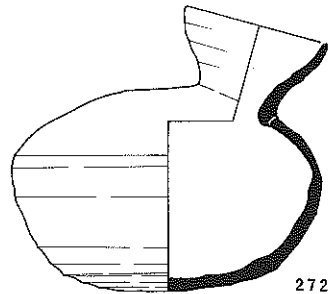
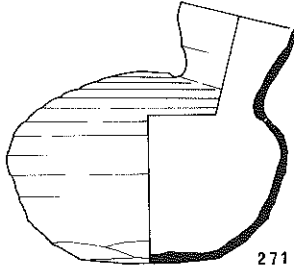
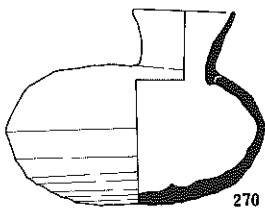
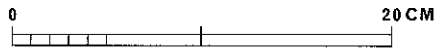
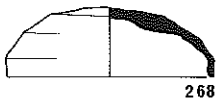

集上り瓦窯跡

図版第四四 陶硯・土製品・特殊品実測図

陶硯

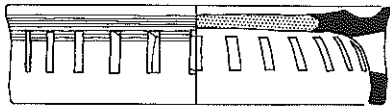

273

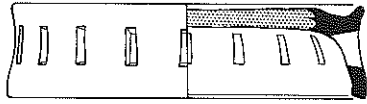

274

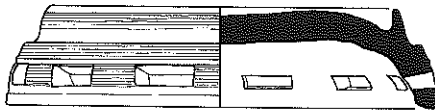

275

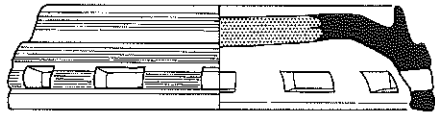

276



277

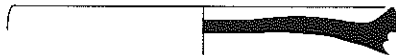

278

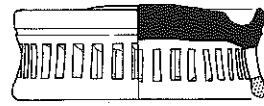

279

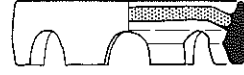

280



281



282



283

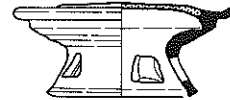

284

土製品

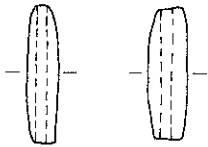

285

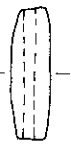

286

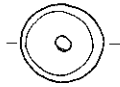

287

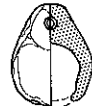

288

特殊品

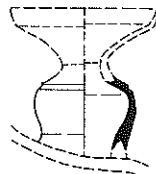

289

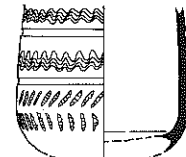

290

