

図 版

遺構等平面図	PLAN 1 ~ 13
土 層 図	SECTION 1 ~ 4
遺物実測図	ARTIFACT 1 ~ 17
写 真	PL 1 ~ 48

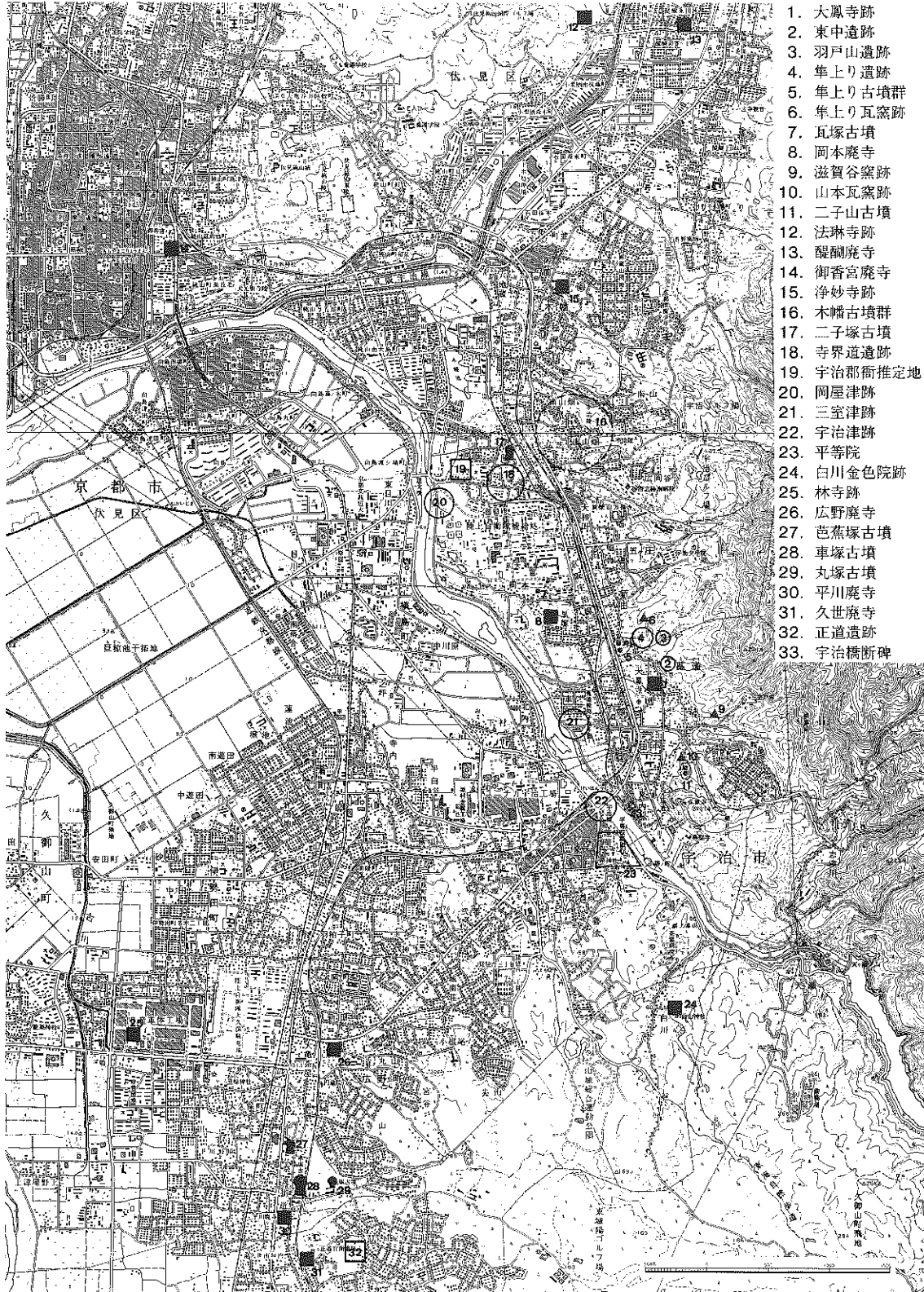

1. 大鳳寺跡
2. 東中遺跡
3. 羽戸山遺跡
4. 隼上り遺跡
5. 隼上り古墳群
6. 隼上り瓦窯跡
7. 瓦塚古墳
8. 岡本麿寺
9. 滋賀谷窯跡
10. 山本瓦窯跡
11. 二子山古墳
12. 法琳寺跡
13. 醍醐麿寺
14. 御香宮麿寺
15. 淨妙寺跡
16. 木幡古墳群
17. 二子塚古墳
18. 寺界道遺跡
19. 宇治郡衙推定地
20. 岡屋津跡
21. 三室津跡
22. 宇治津跡
23. 平等院
24. 白川金色院跡
25. 林寺跡
26. 広野麿寺
27. 芭蕉塚古墳
28. 車塚古墳
29. 丸塚古墳
30. 平川麿寺
31. 久世麿寺
32. 正道遺跡
33. 宇治橋断碑

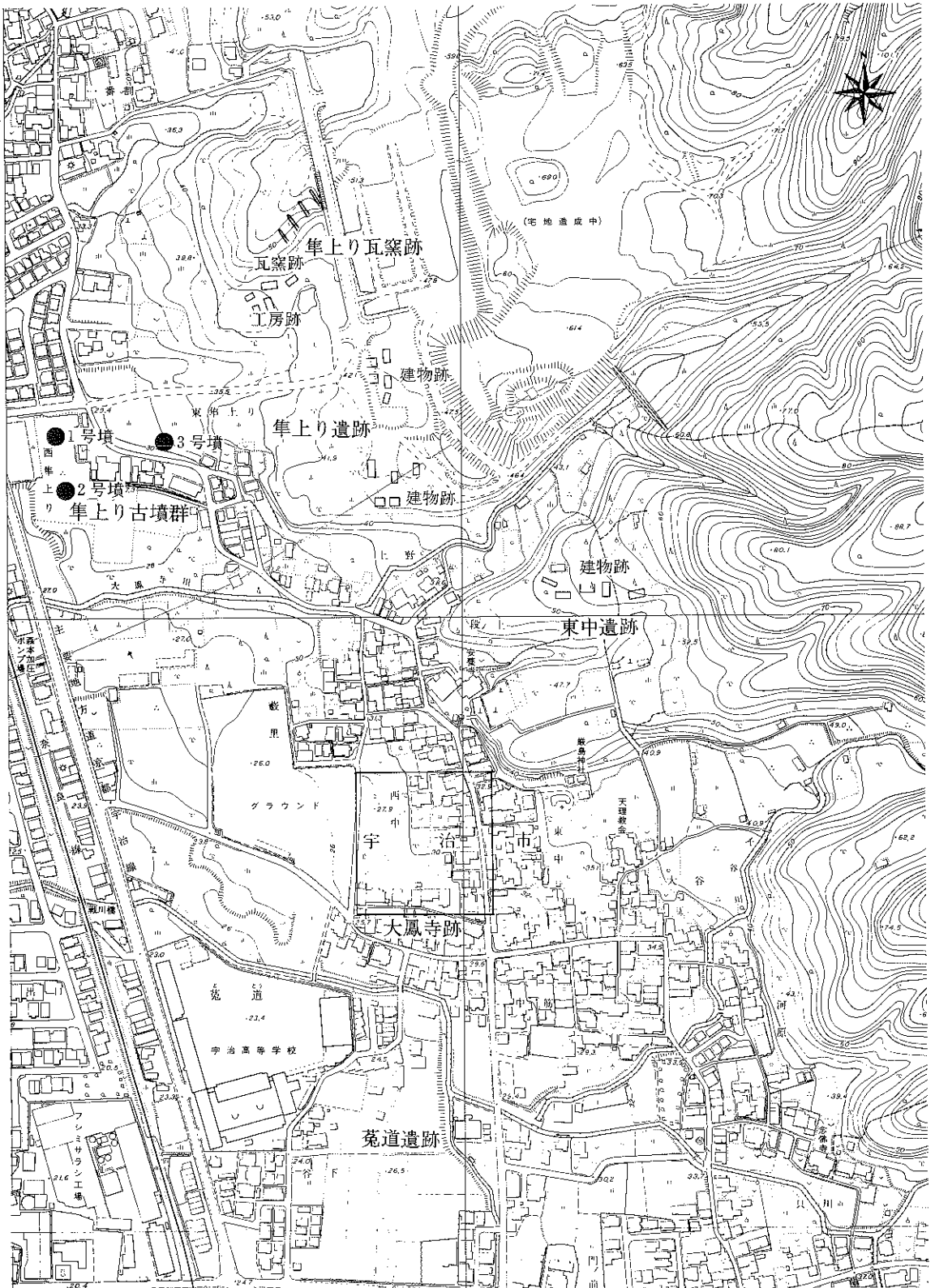

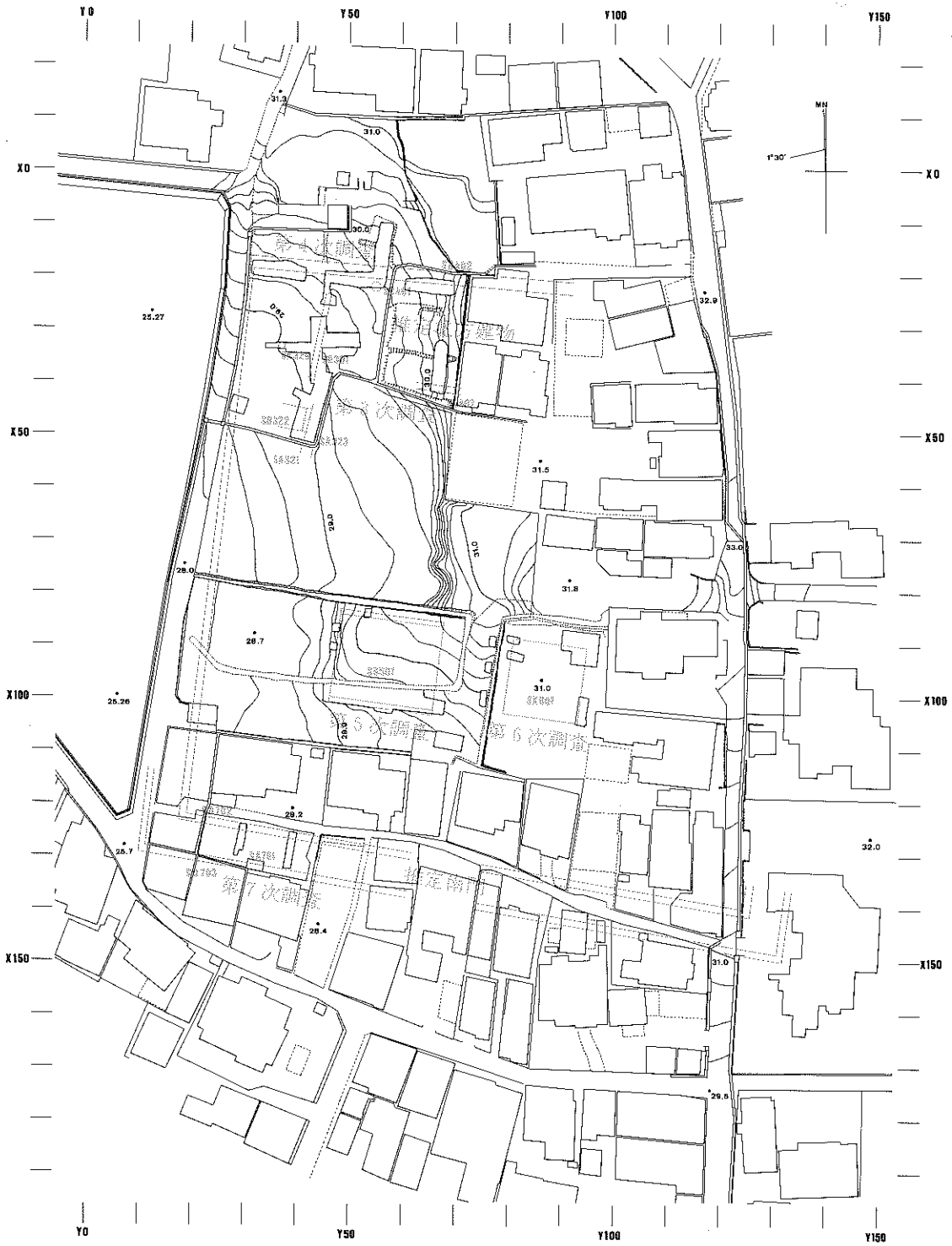

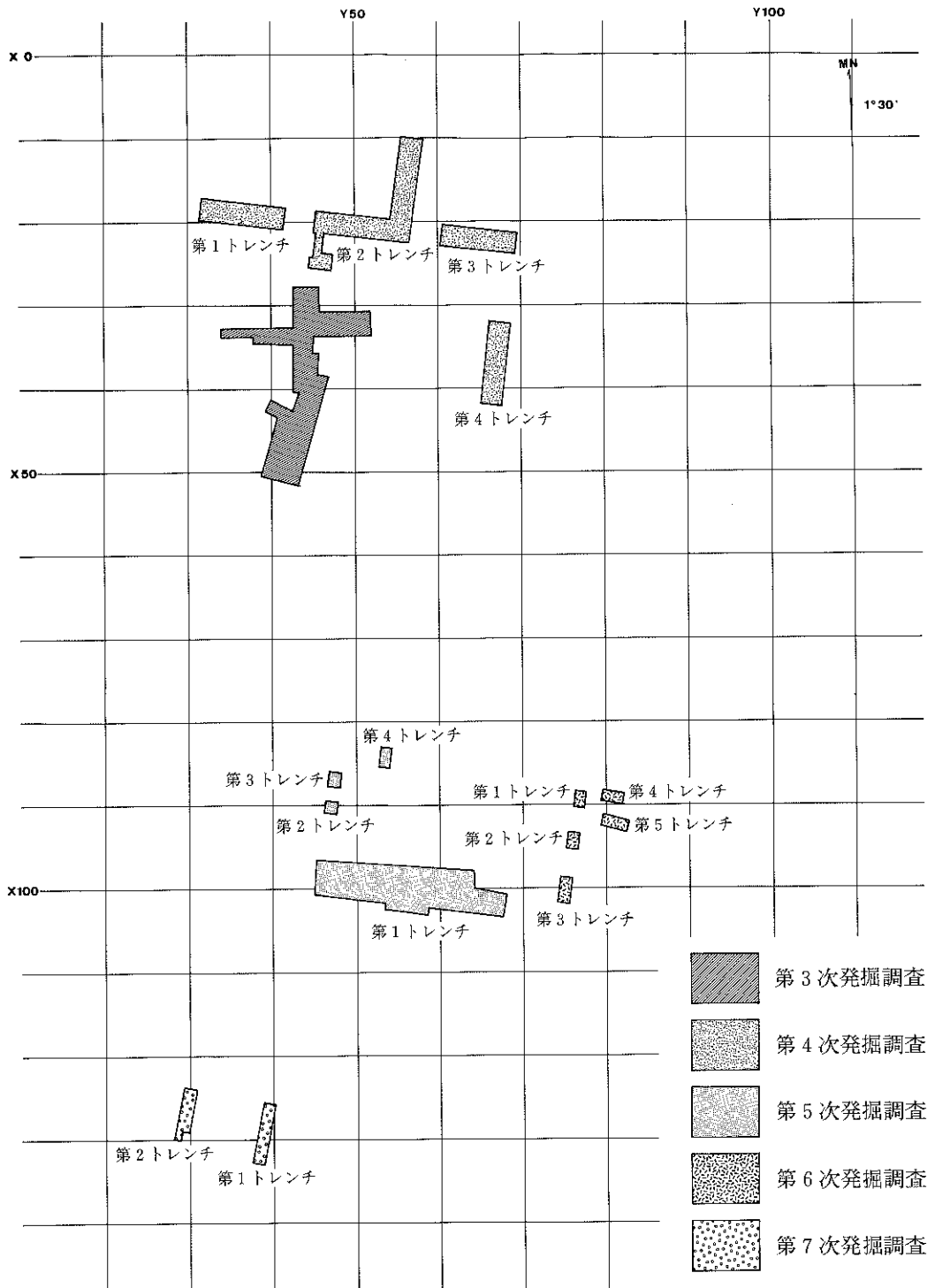

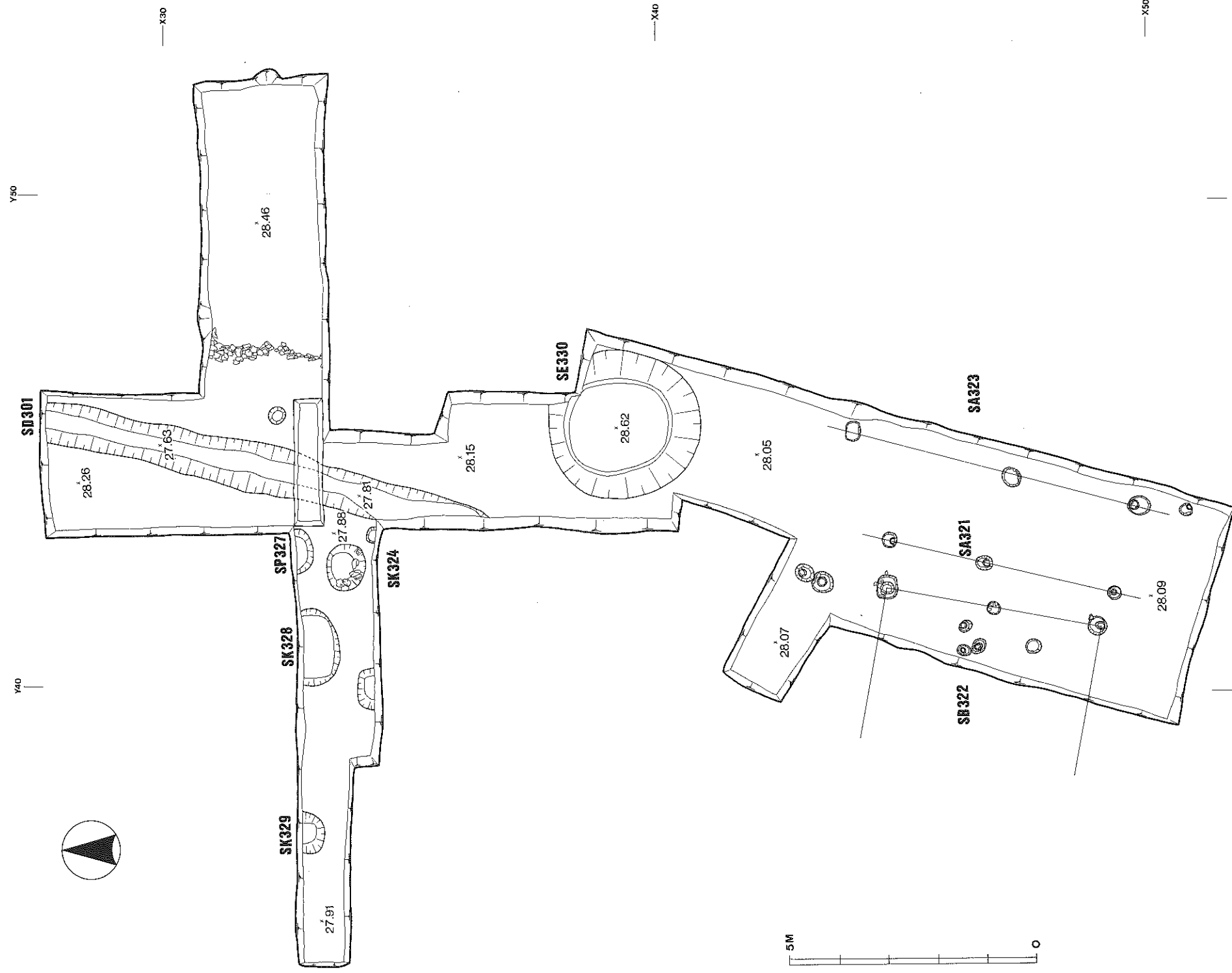

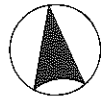

Y35

Y45

Y55

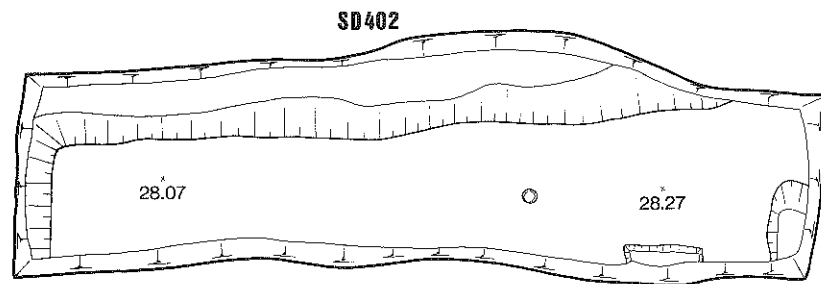

第1トレンチ

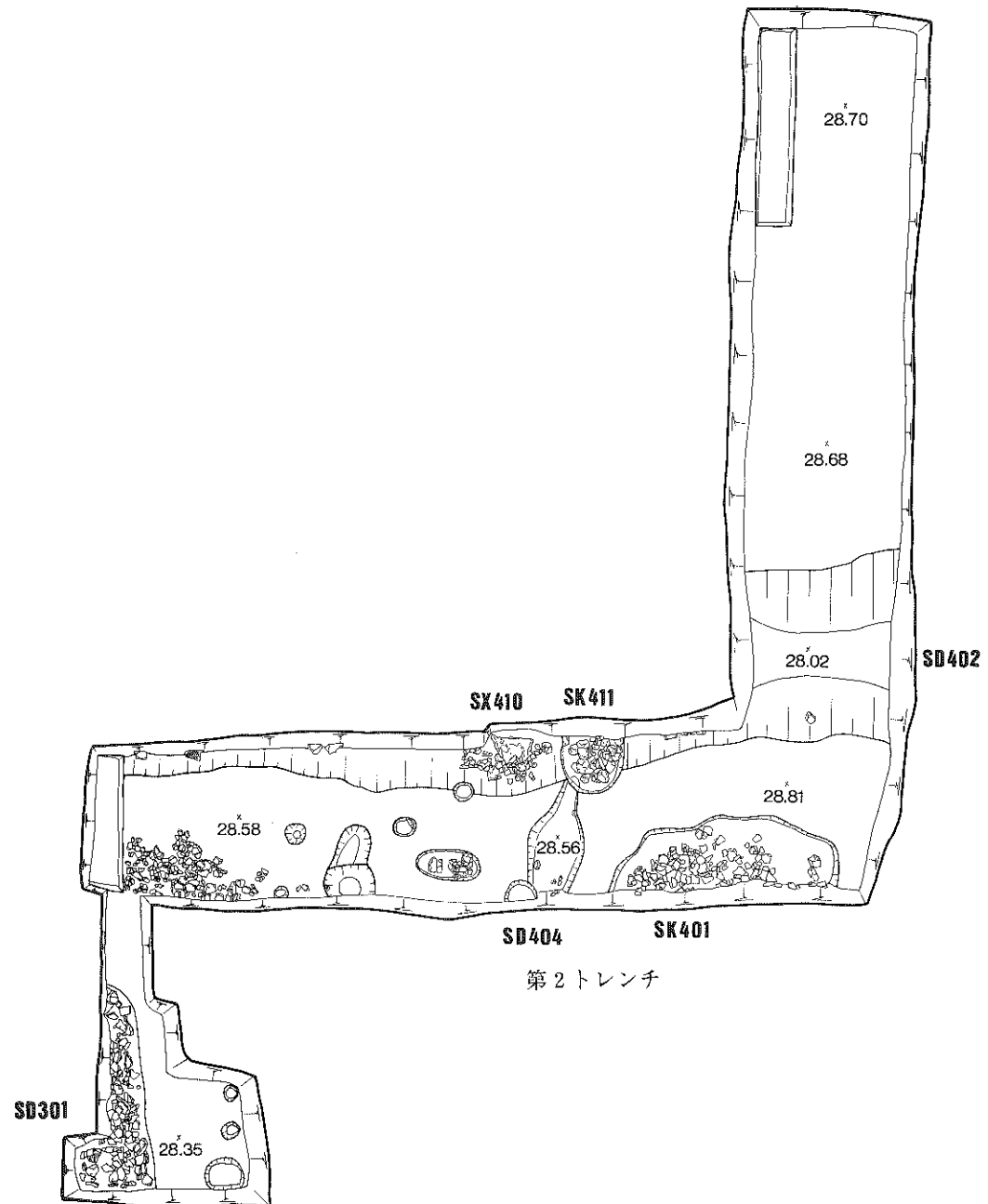

第2トレンチ



X15

X25

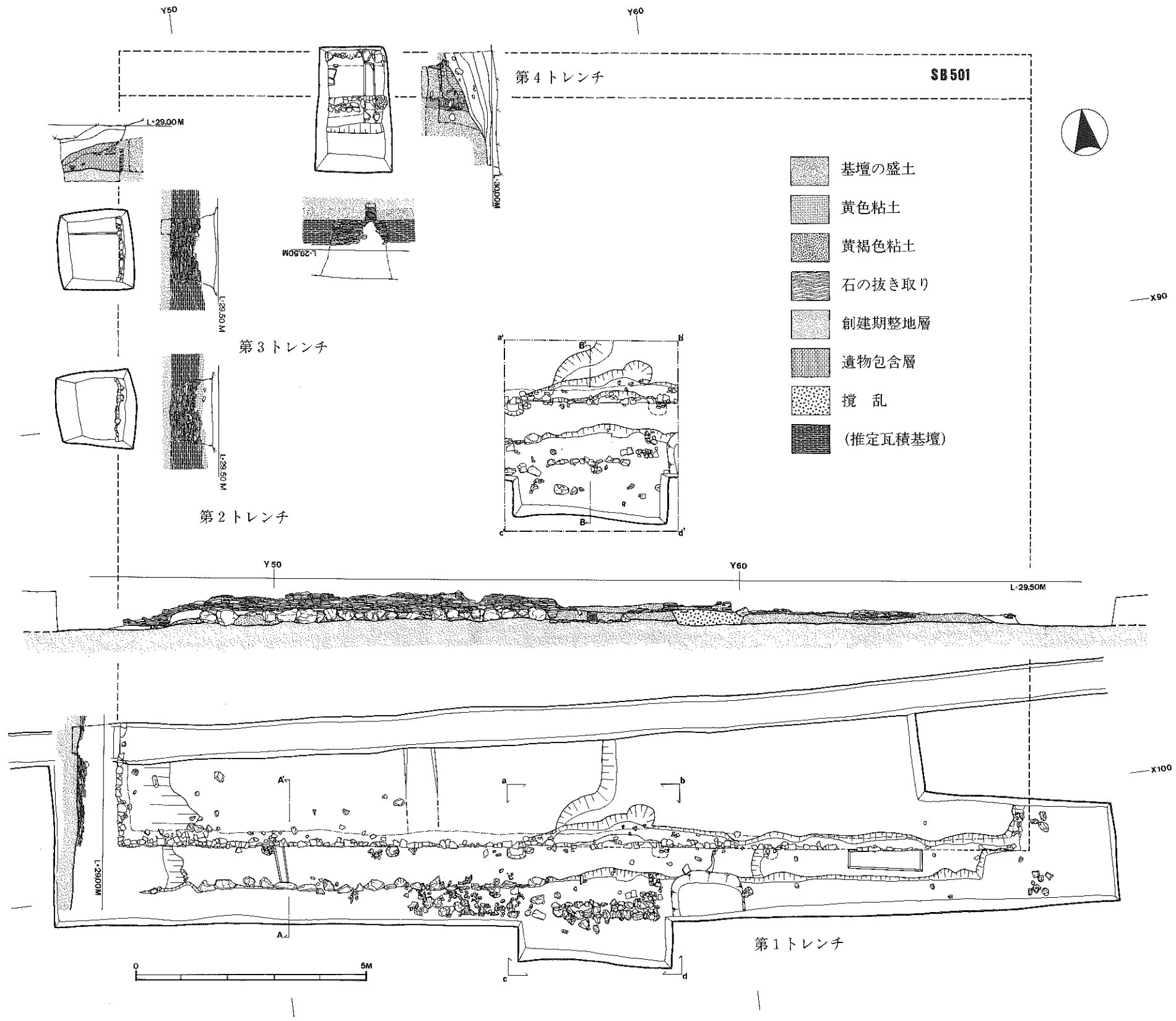

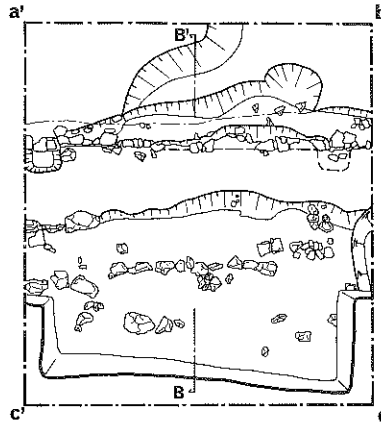

Y60

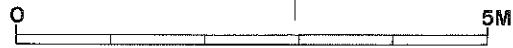
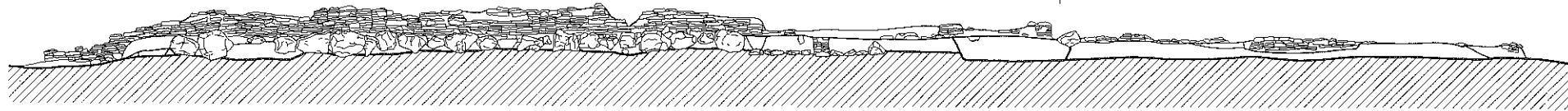
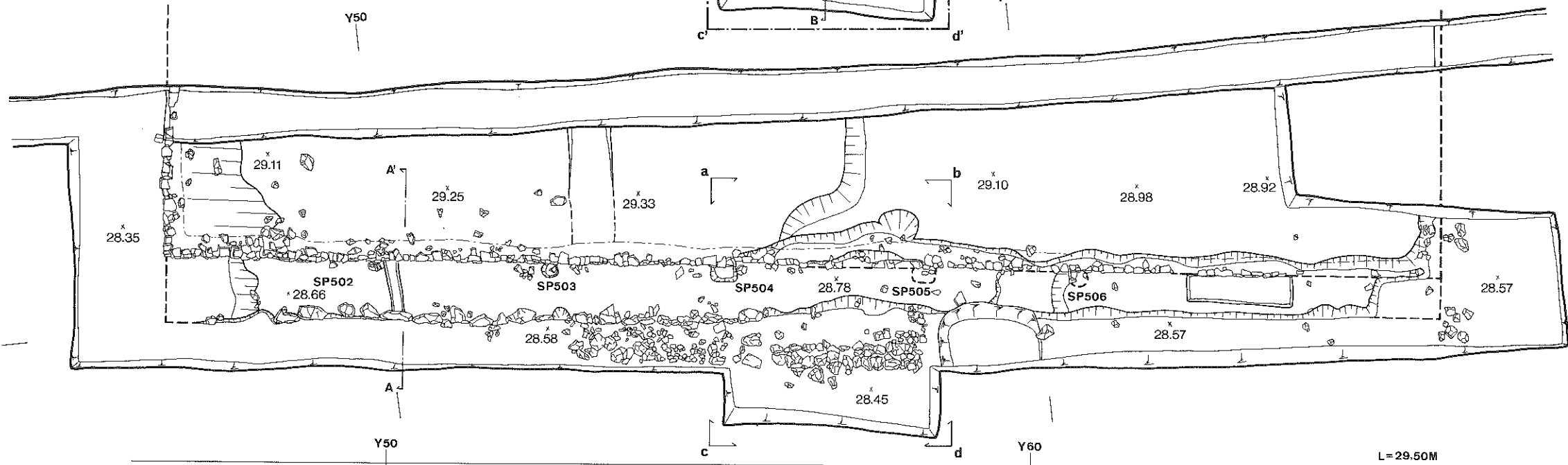

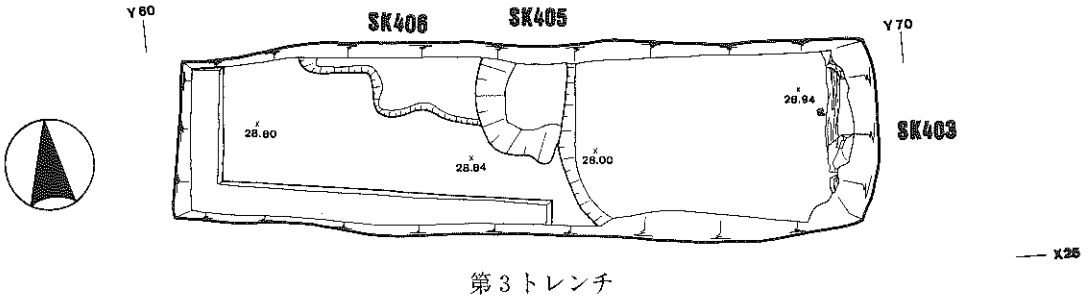

第4トレンチ

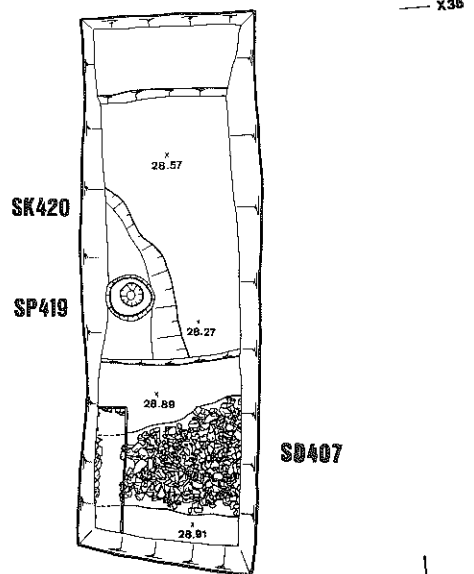

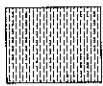

包含層

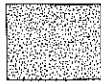

基壇の盛土

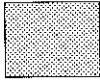

黄色粘土



創建期整地層

1. 表土 2. 旧の耕作土 3. 暗褐色混礫土 4. 淡褐色土
(瓦多く含む)

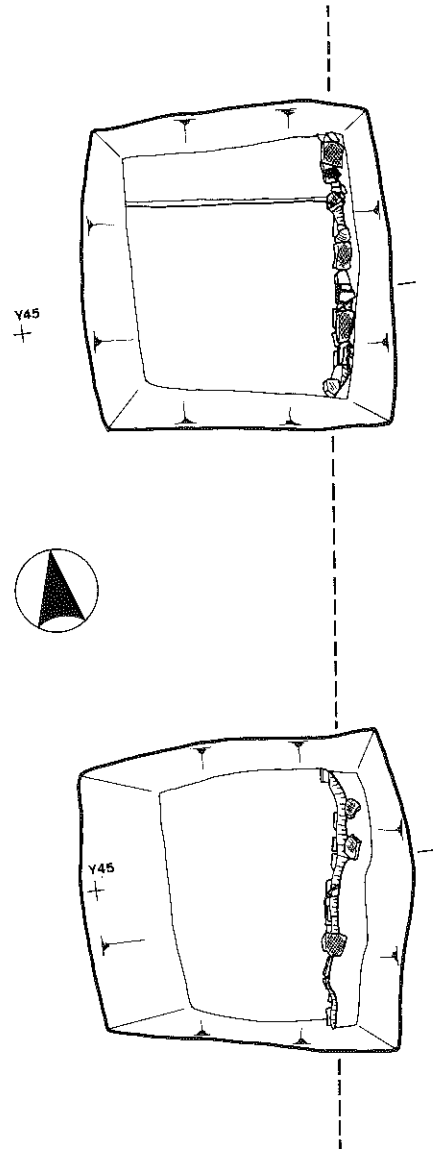
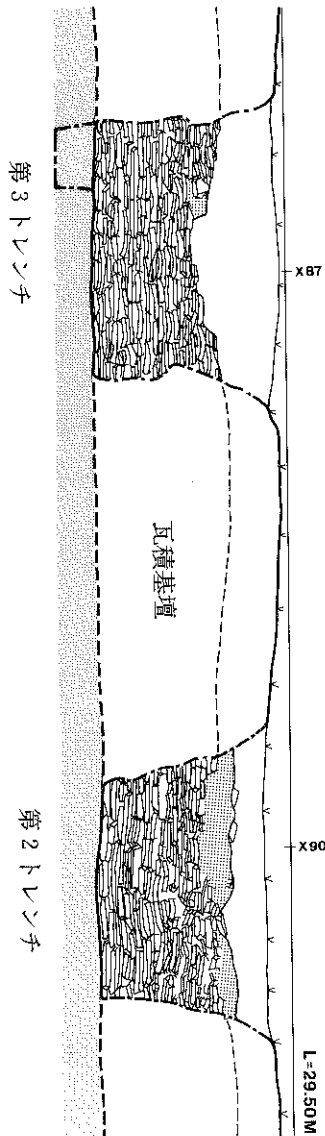
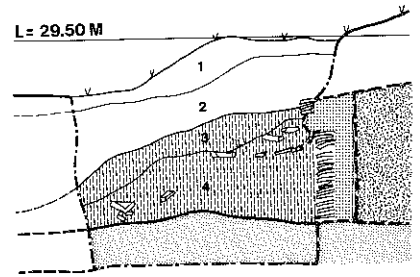

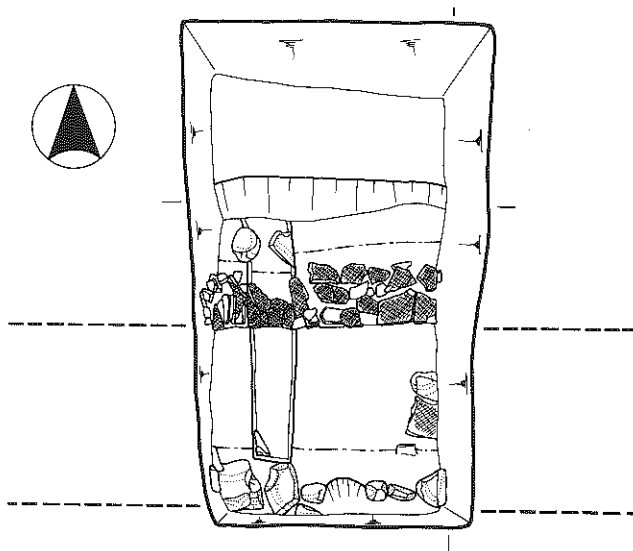
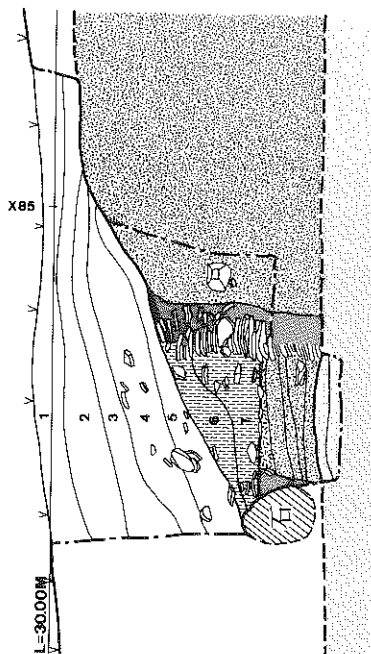

第4トレンチ



基壇の盛土

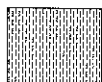

包含層

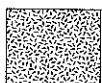

黄褐色粘土

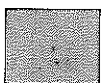

黄色粘土

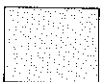

創建期整地層

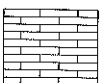

推定下成基壇

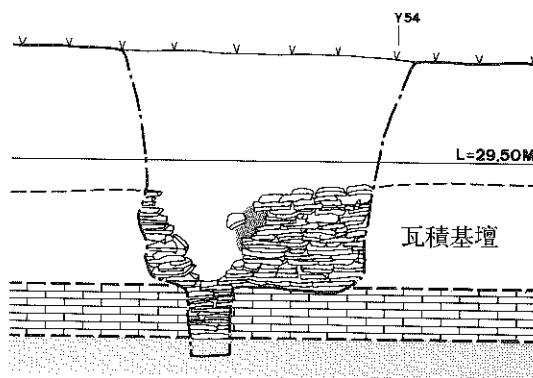

瓦積基壇

1. 表土
2. 暗褐色土(盛土)
3. 旧耕作土
4. 暗褐色土(盛土)
5. 黒褐色土(旧表土)
6. 淡褐色土
7. 淡褐色土(瓦を多く含む)



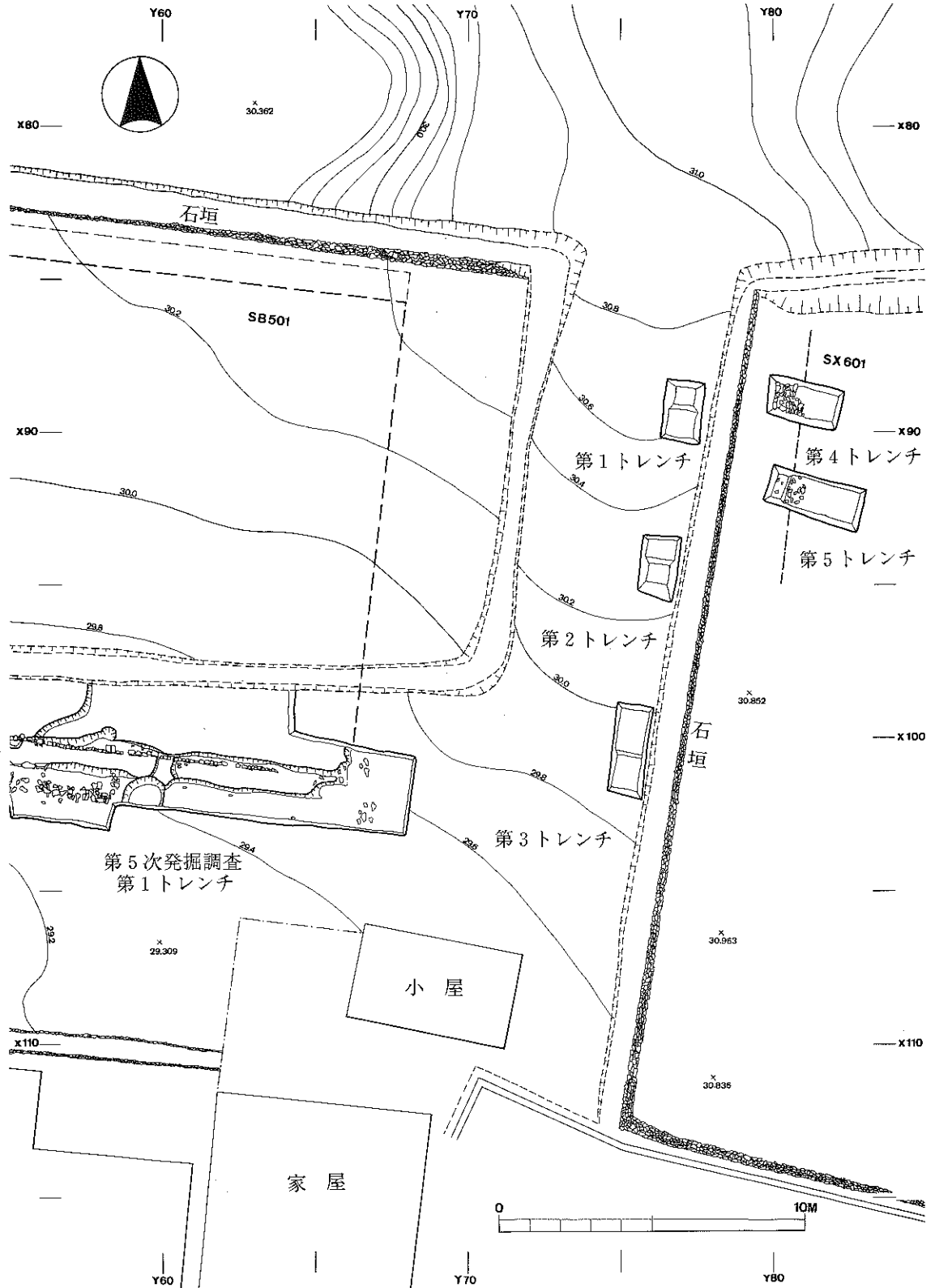

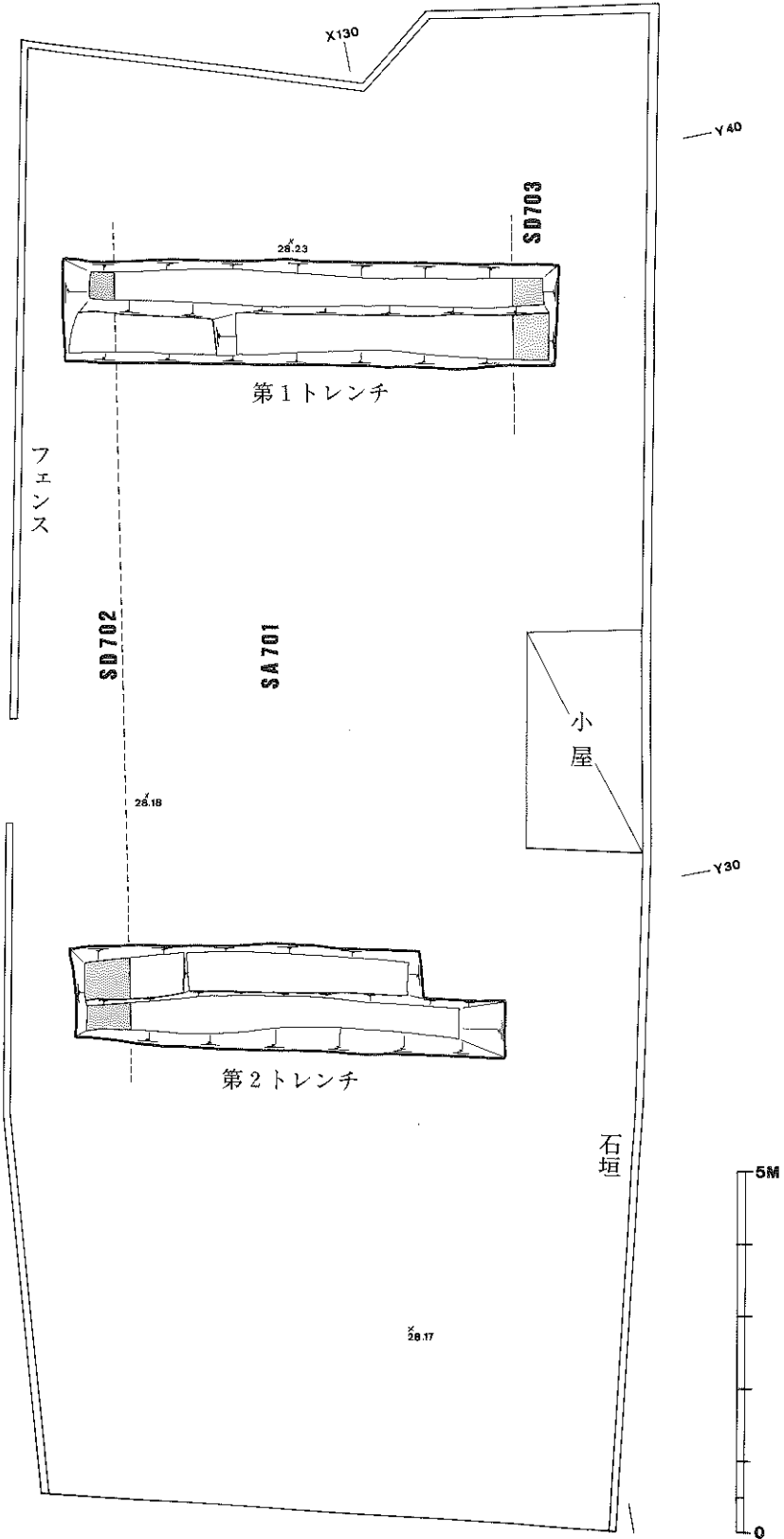

中央北壁

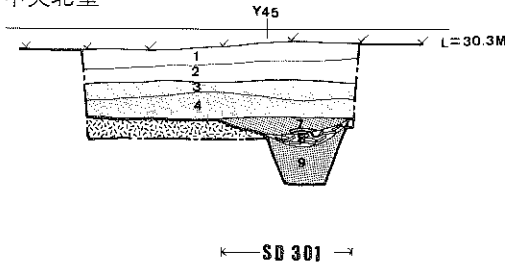

1. 表土・耕作土
 2. 淡褐色粘質土(近世)
 3. 淡褐色土
 4. 暗褐色土
 5. 黄褐色粘質土
 6. 礫層
 7. 暗褐色粘質土(上層)
 8. 瓦層(中層)
 9. 茶褐色粘質土(下層)
- } SD301埋土

東拡張部北壁

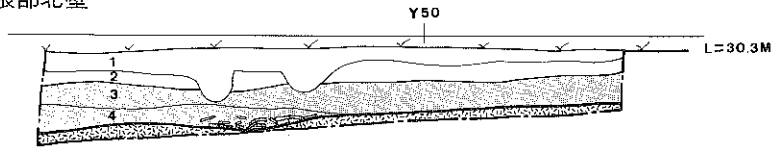

西拡張部北壁

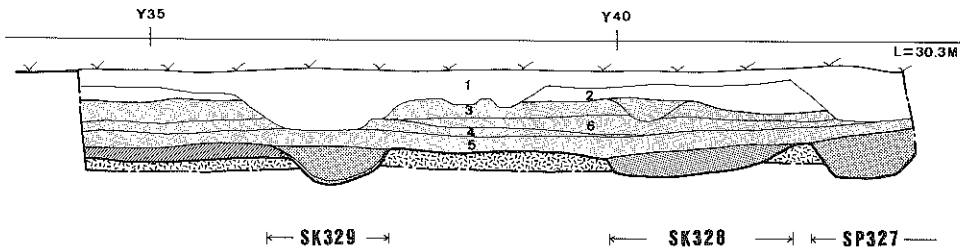

遺物包含層



遺構埋土



灰層



創建期整地層



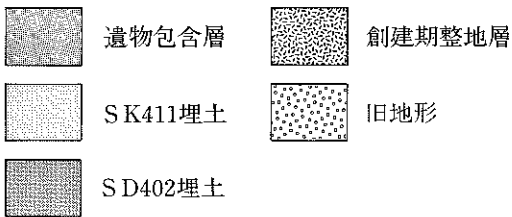
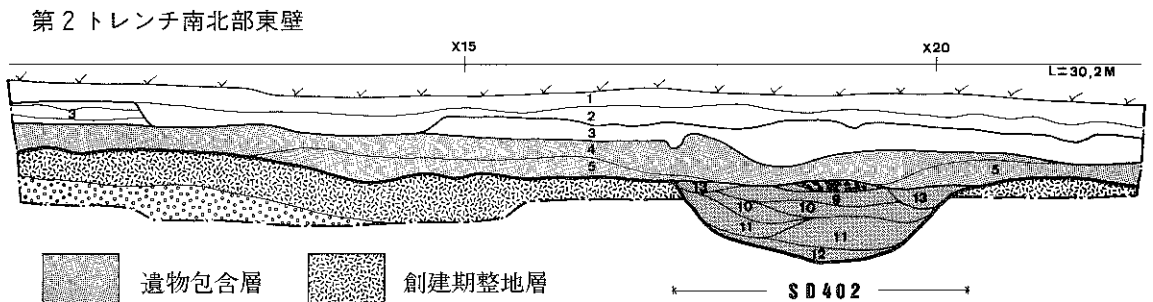
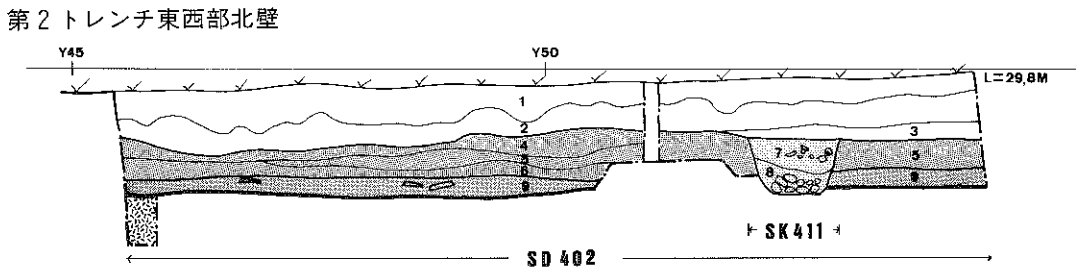
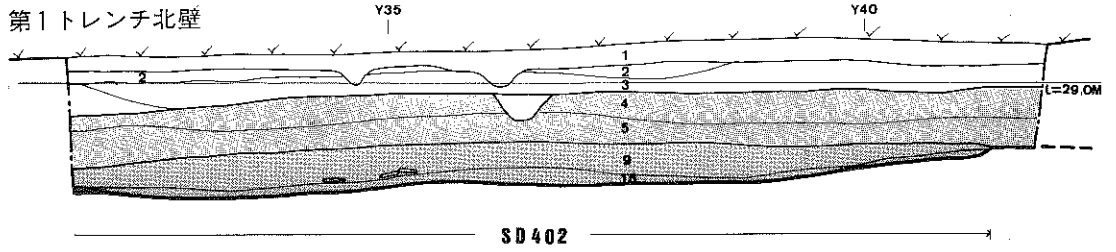

- | | |
|---------------|------------|
| 1. 表土 | 9. 暗褐色砂質土 |
| 2. 淡褐色土(近世) | 10. 青灰色混礫土 |
| 3. 淡褐色粘質土(近世) | 11. 青灰色粘土 |
| 4. 淡褐色土 | 12. 青灰色泥土 |
| 5. 暗褐色混礫土 | 13. 暗褐色土 |
| 6. 灰色砂質土 | 14. 礫層 |
| 7. 暗褐色土 | 15. 暗褐色砂礫土 |
| 8. 暗褐色混礫土 | |

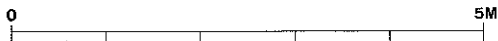

第3トレンチ北壁

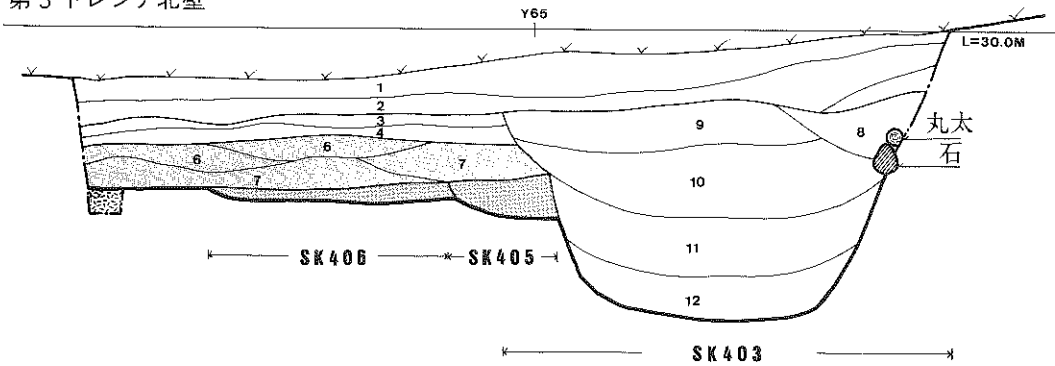

第4トレンチ西壁

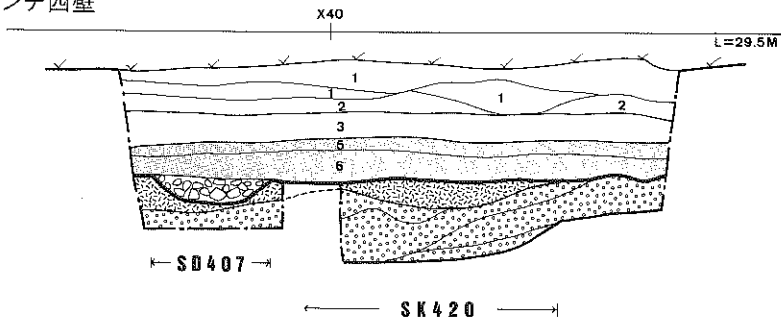

遺物包含層



SK405・SK406埋土



創建期整地層



旧地形

1. 表土・耕作土

2. 淡褐色土(近世)

3. 淡褐色粘質土(近世)

4. 暗褐色土

5. 黄褐色砂質土

6. 暗褐色粘質混礫土

7. 暗褐色混礫土

8. 礫層

9. 淡褐色粘質土

10. 暗灰色粘土

11. 青灰色粘土

12. 泥土

} SK403埋土



第1トレンチ東壁

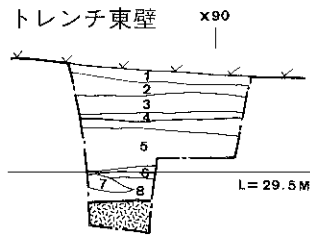

第2トレンチ東壁

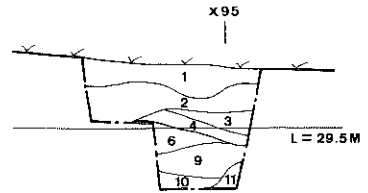

第3トレンチ東壁

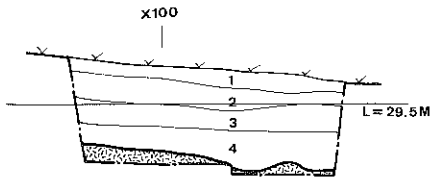

- | | |
|---------------|-----------------|
| 1. 表土・耕作土 | 9. 淡褐色粘質土 |
| 2. 淡褐色砂質土 | 10. 淡褐色粘質土(鉄分含) |
| 3. 黄褐色土 | 11. 灰白粘土 |
| 4. 暗褐色砂質土(炭含) | 12. 暗褐色土 |
| 5. 淡褐色粘土 | 13. 灰白粘質混礫土 |
| 6. 淡褐色土(炭含) | |
| 7. 黄褐色砂質土 | |
| 8. 茶褐色砂質土 | |

第4トレンチ北壁

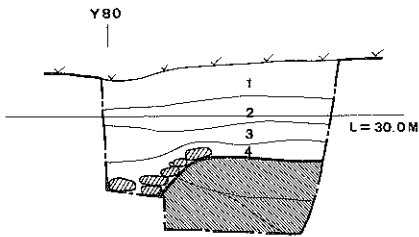

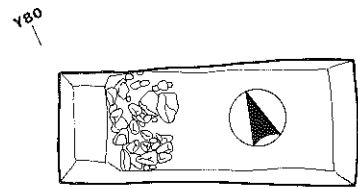
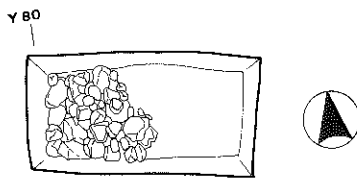
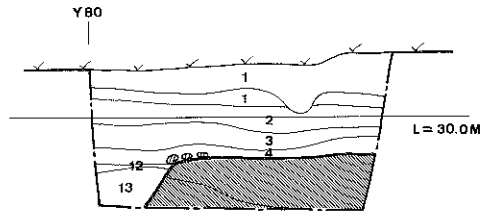

第5トレンチ北壁



x90
SX 601

Y80
SX 601

-  SX601盛土
-  創建期整地層

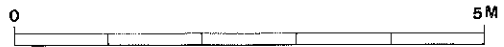

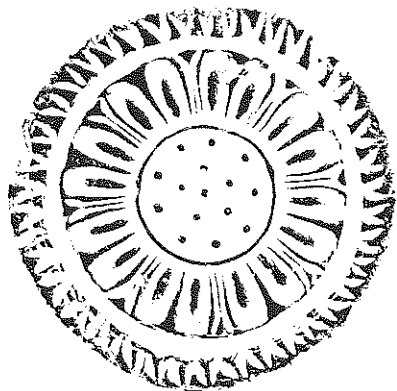

NM01

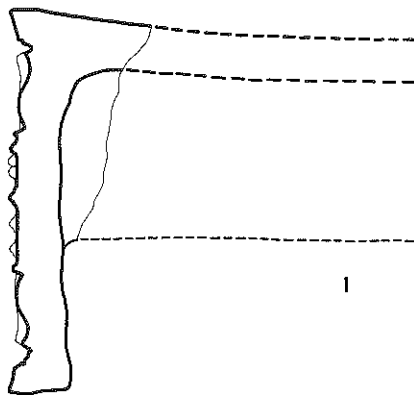

1

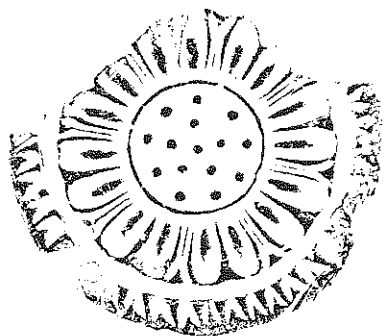

NM01

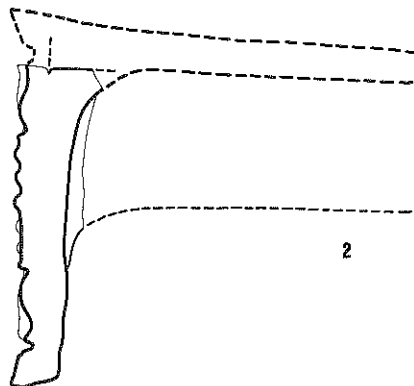

2

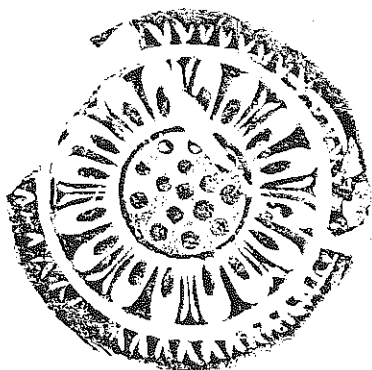

NM01

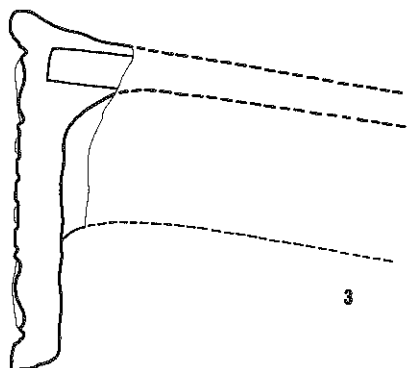

3

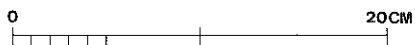



NM02

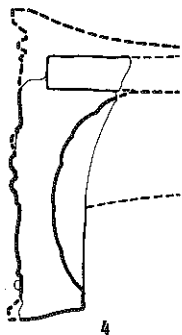

4

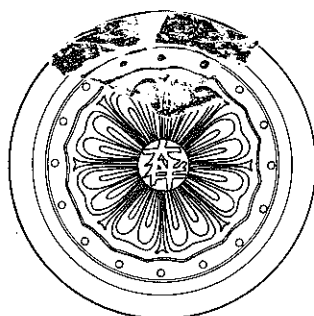

NM05



7

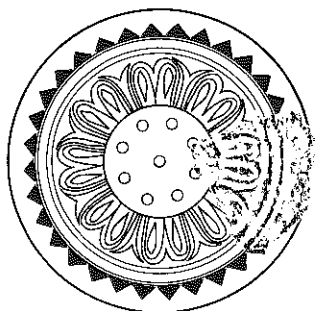

NM03

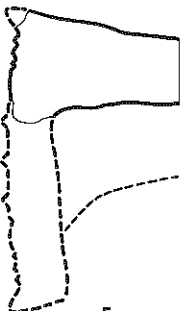

5

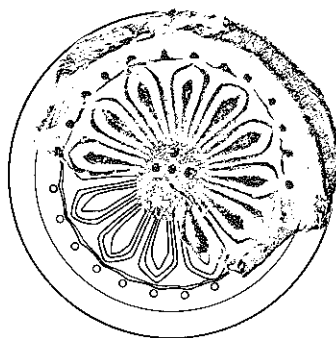

NM06

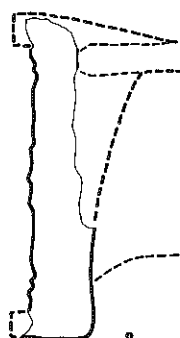

8

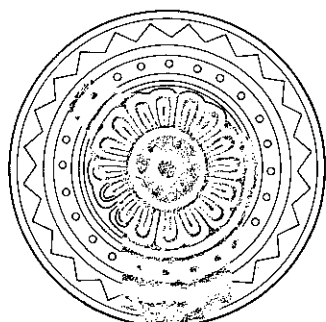

NM04

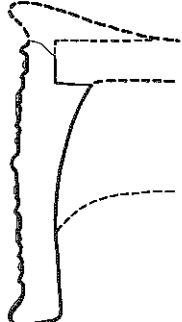

6

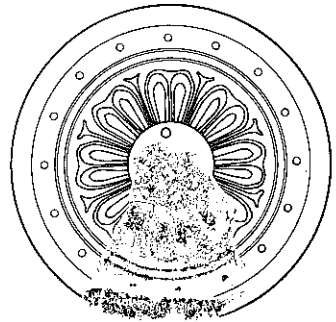

NM07

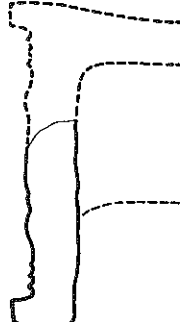

9

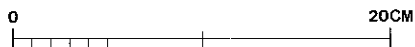



NH01



10



NH01



11

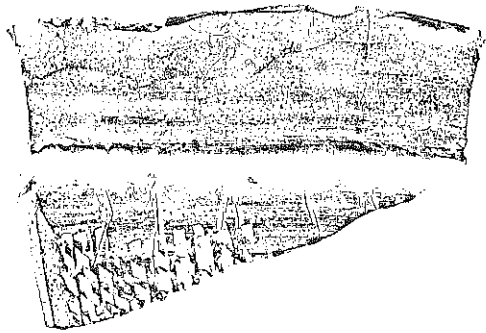
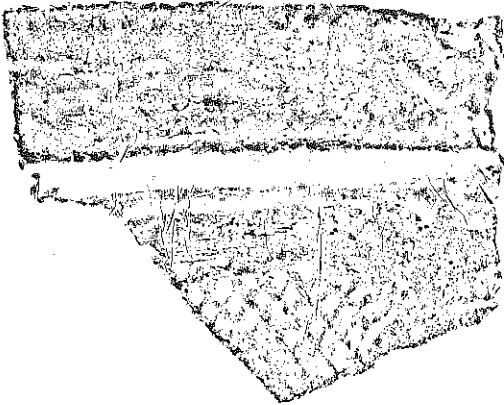

NH01

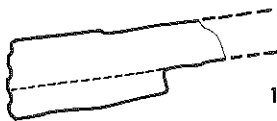

12

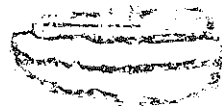

NH01

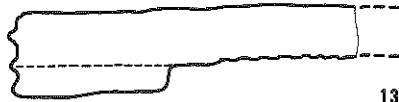

13

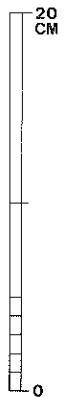
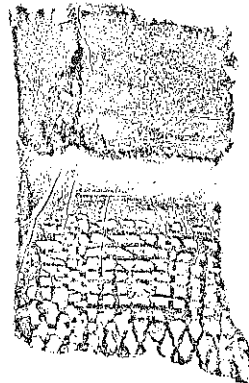
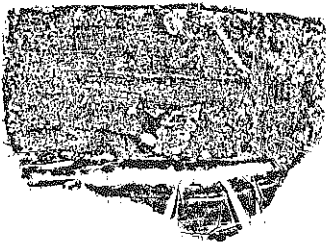

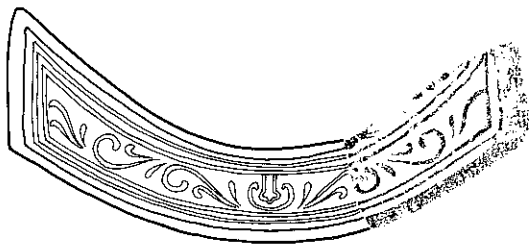

NH02



NH03



NH04

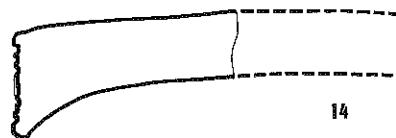

14



15



16



17

OG02

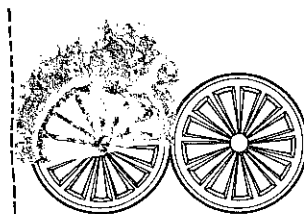

18

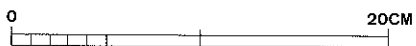

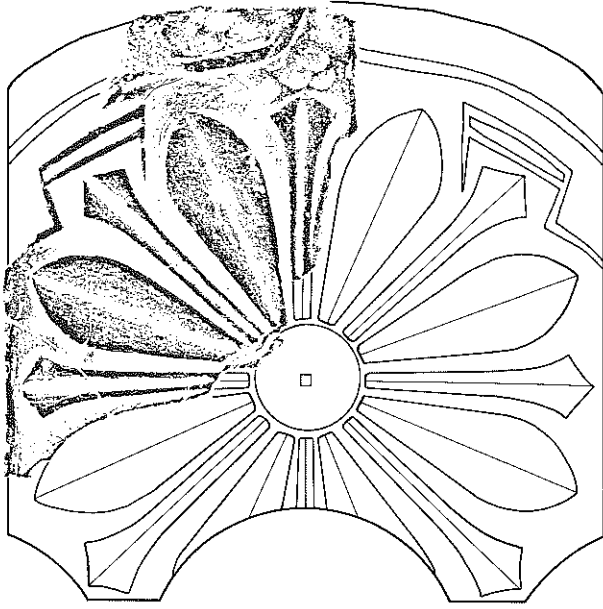

0601



19

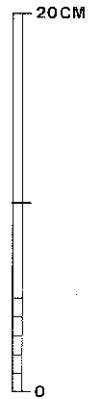
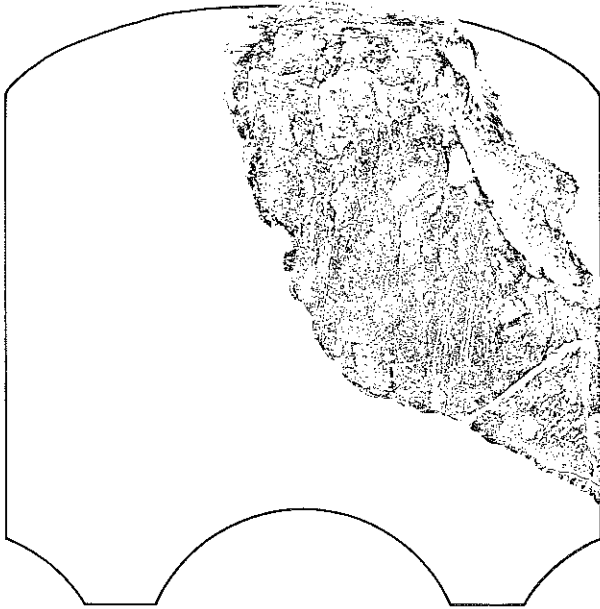

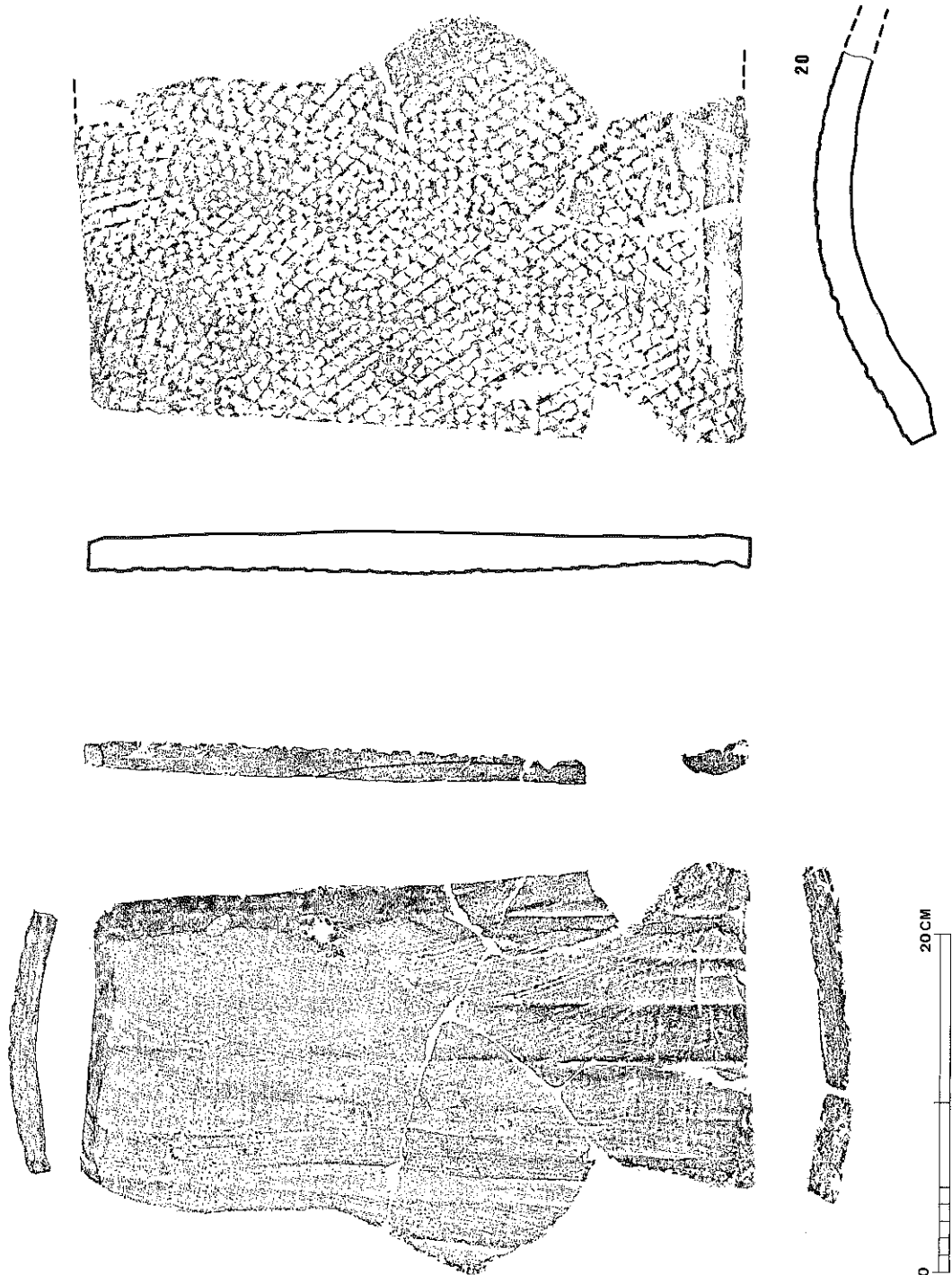

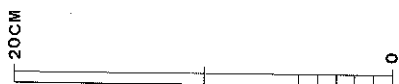
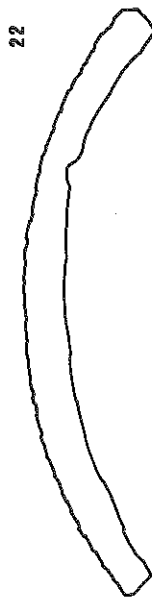
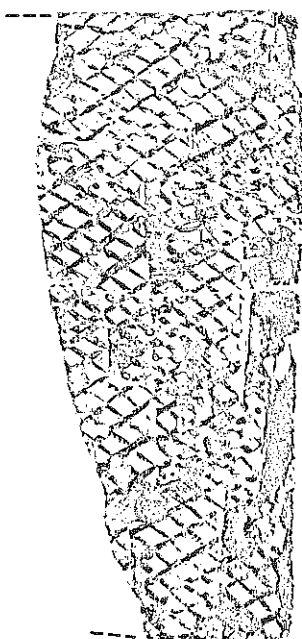
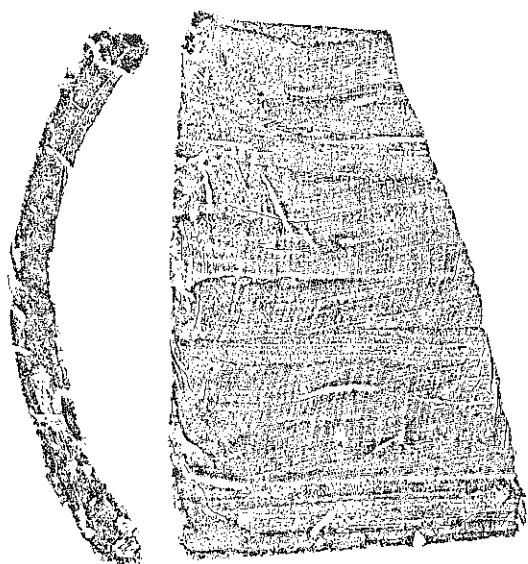

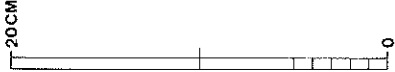
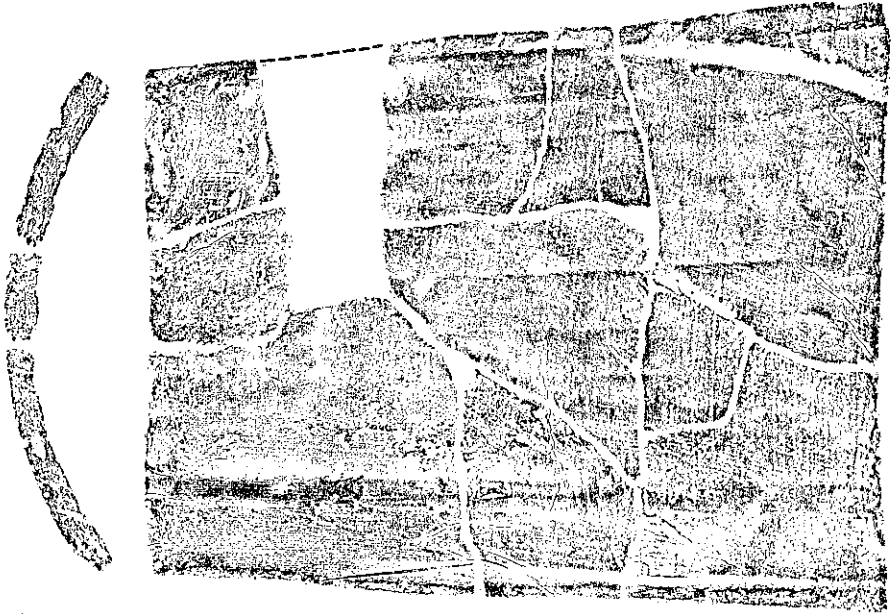
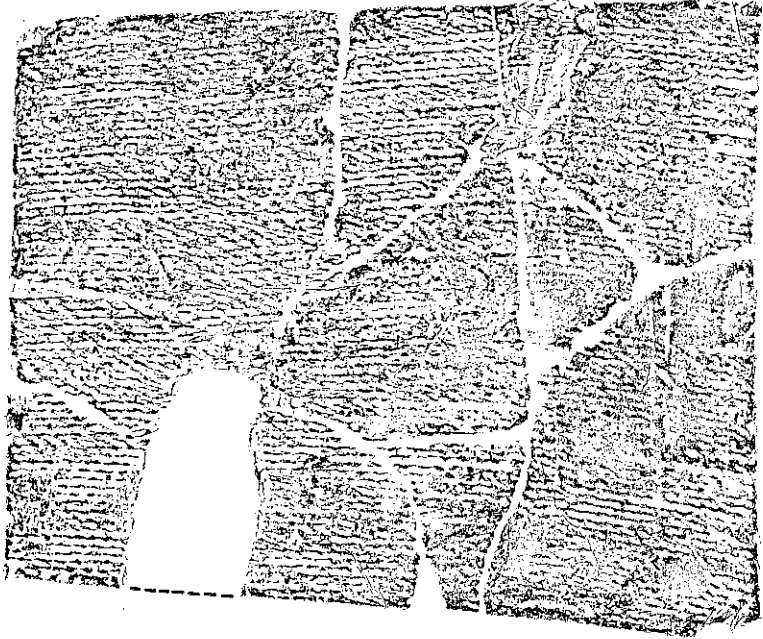



2A

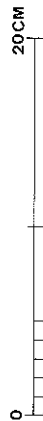
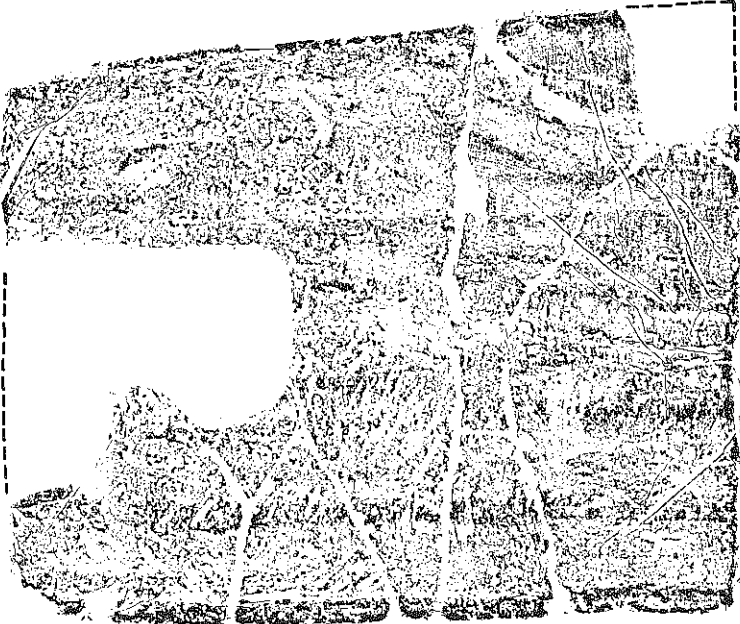

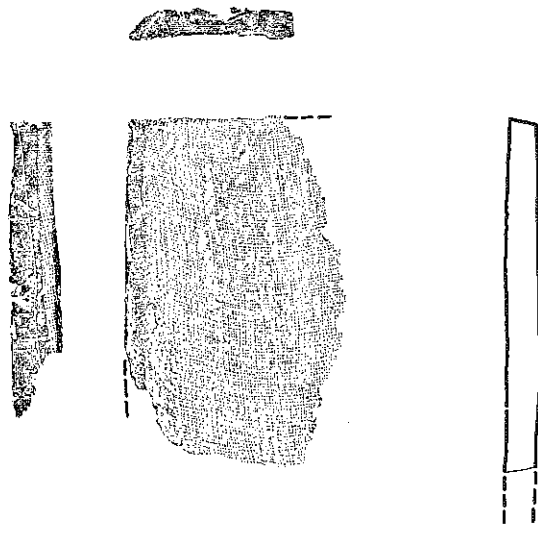
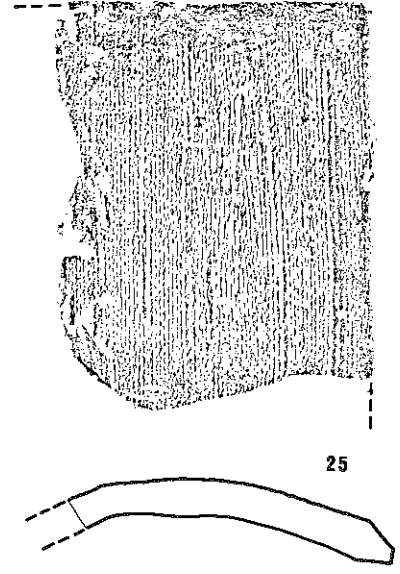
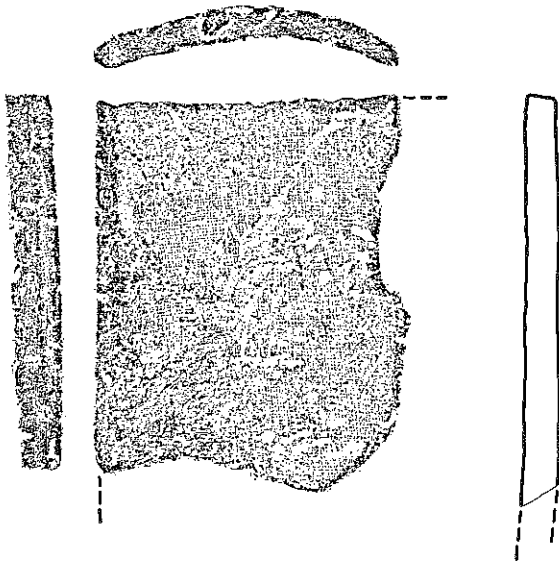

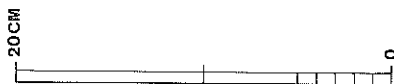
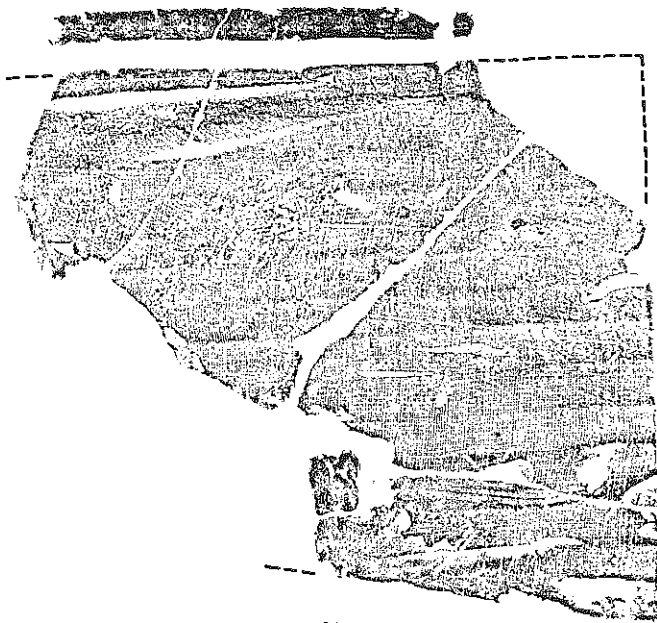

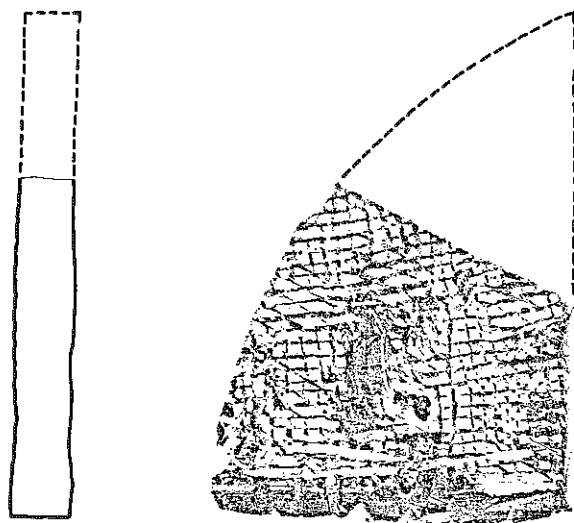
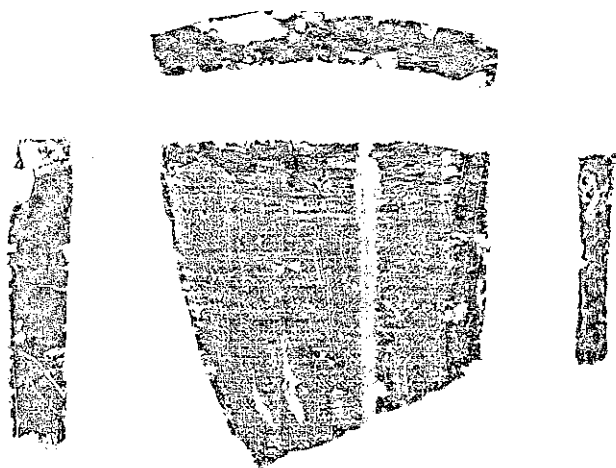

30

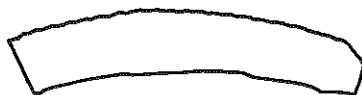

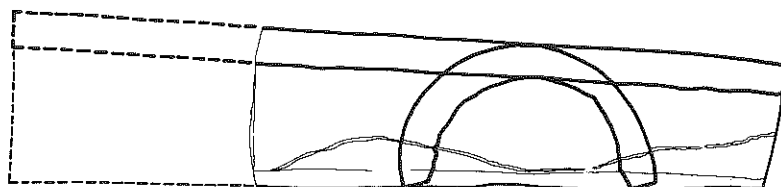
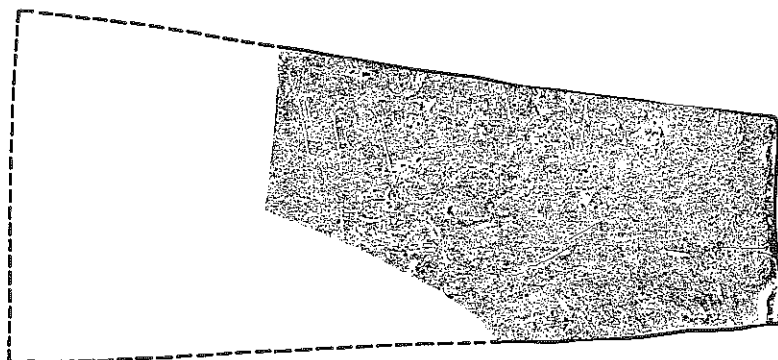

28

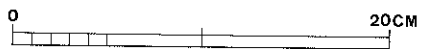
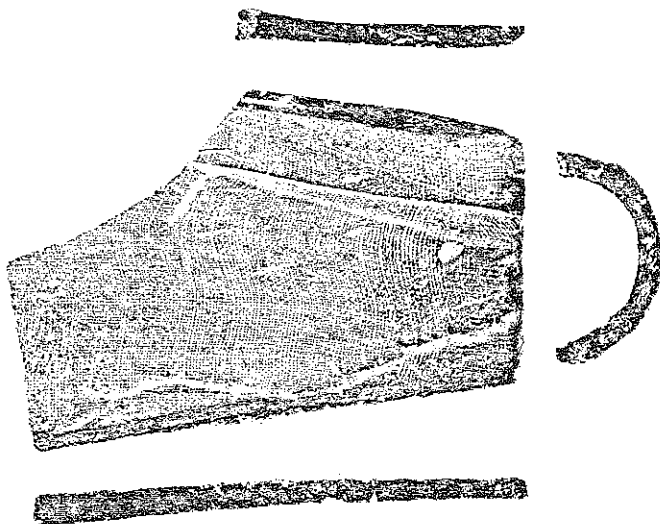

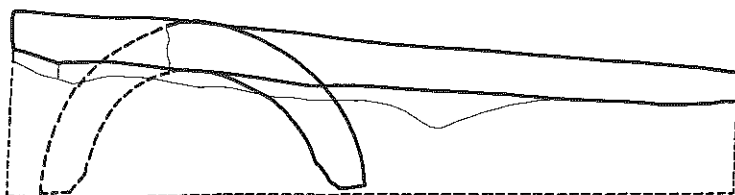
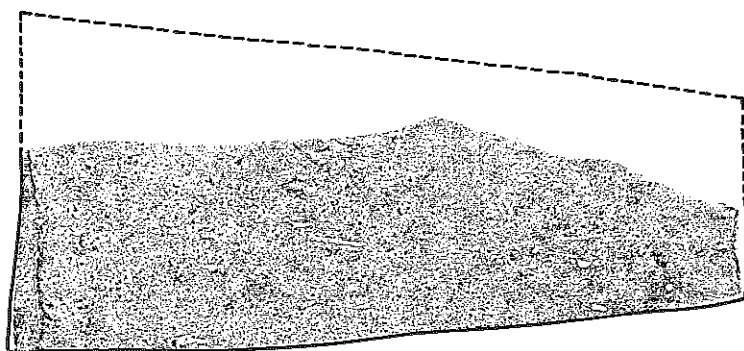

29

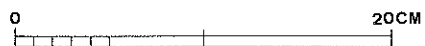
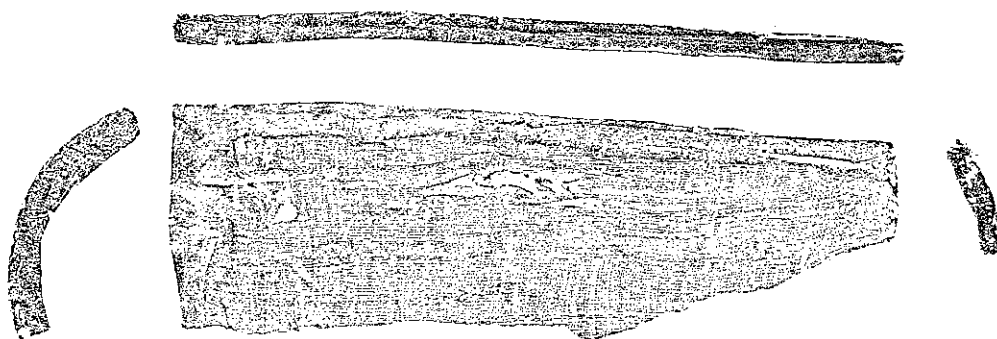

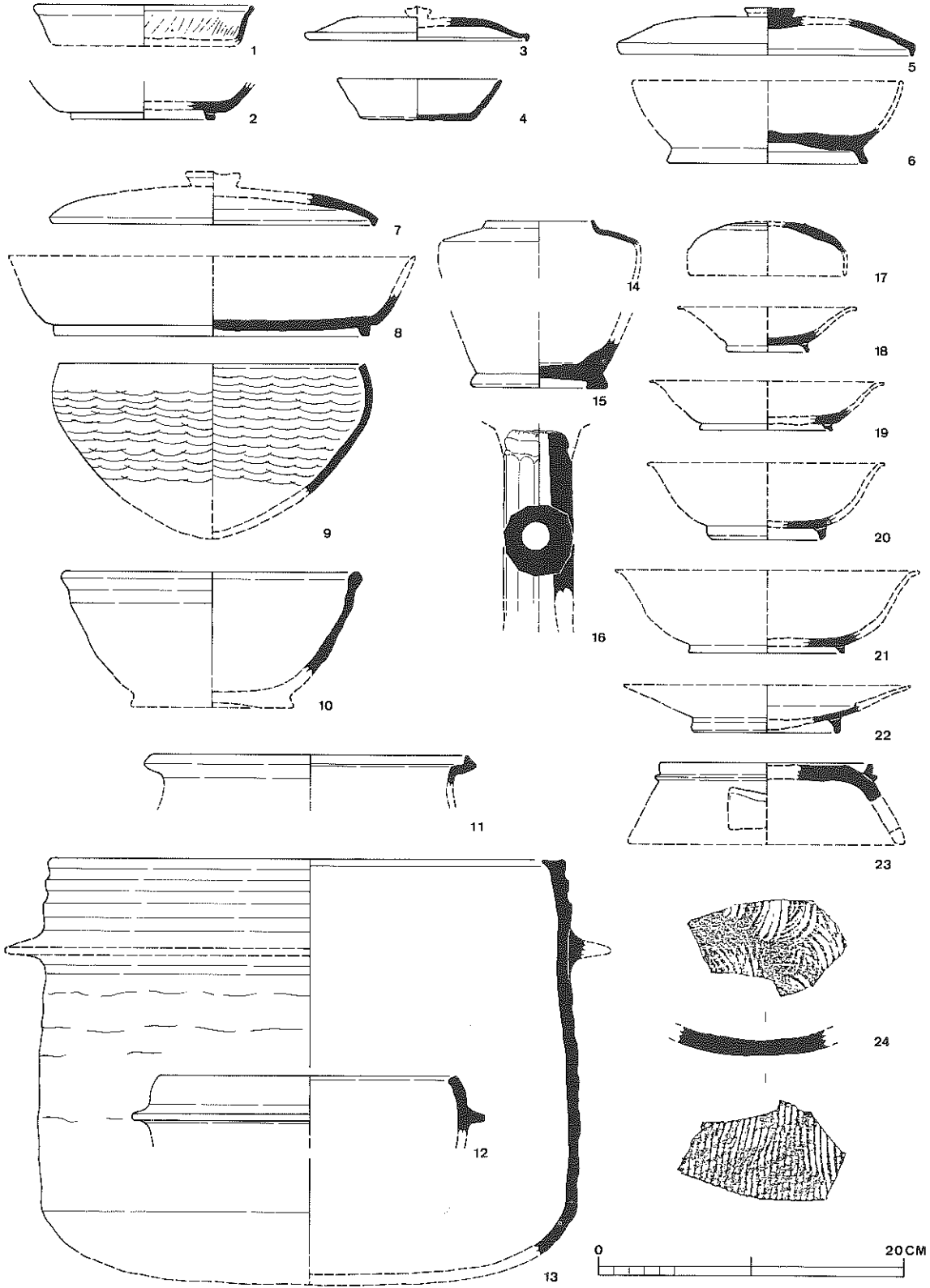

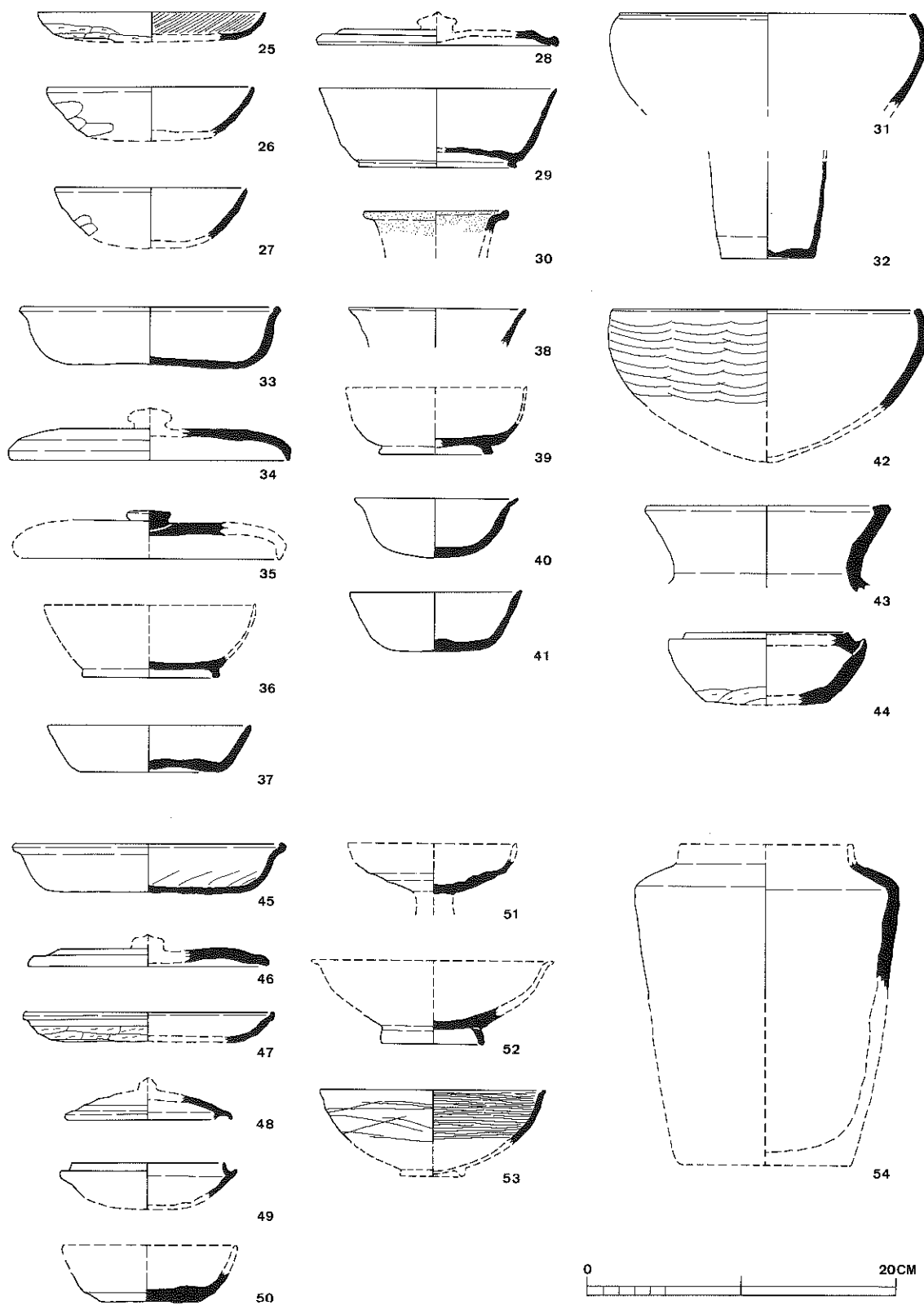

0 20CM

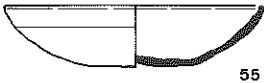

55

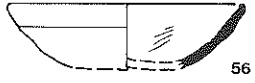

56



57

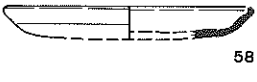

58

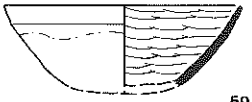

59



60

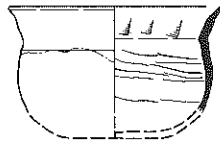

61



62

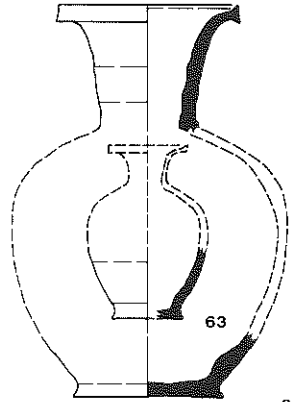

63

64

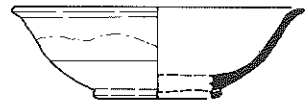

65

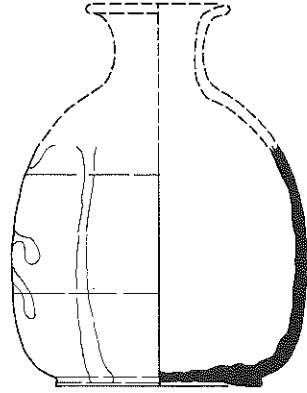

66

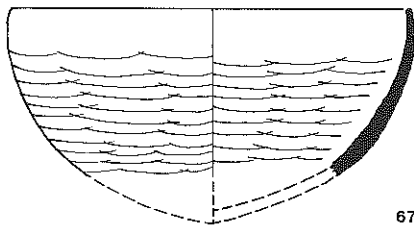

67

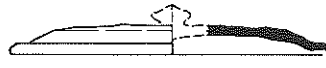

72

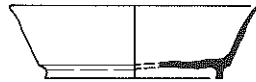

73



74

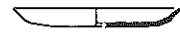

75

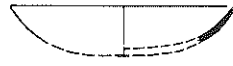

76

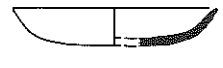

77



78



68

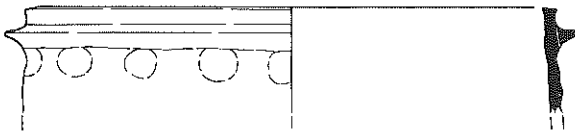

69

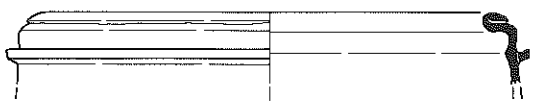

70

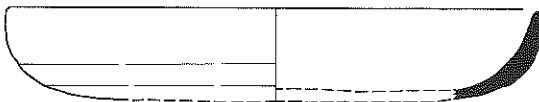

71

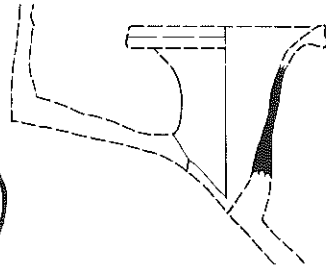

79

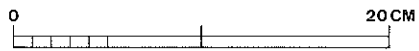

20 CM

